



Article scientifique

Article

2003

Published version

Public access

This is the published version of the publication, made available in accordance with the publisher's policy.

Beans (*Phaseolus* spp.) – model food legumes

Broughton, William John; Hernández, G.; Blair, M.; Beebe, S.; Gepts, P.; Vanderleyden, J.

How to cite

BROUGHTON, William John et al. Beans (*Phaseolus* spp.) – model food legumes. In: *Plant and Soil*, 2003, vol. 252, n° 1, p. 55–128. doi: 10.1023/A:1024146710611

This publication URL: <https://archive-ouverte.unige.ch/unige:113666>

Publication DOI: [10.1023/A:1024146710611](https://doi.org/10.1023/A:1024146710611)

© This document is protected by copyright. Please refer to copyright holder(s) for terms of use.

Last deposit update in Archive ouverte UNIGE on 15.03.2023 16:39



Beans (*Phaseolus* spp.) – model food legumes

W. J. Broughton^{1,6,**}, G. Hernández², M. Blair³, S. Beebe³, P. Gepts⁴ & J. Vanderleyden⁵

¹LBMPs, Université de Genève, 1 ch. de l'Impératrice, 1292 Chambésy, Genève, Switzerland. ²CIFN, UNAM, Cuernavaca, Mexico. ³CIAT, Cali, Colombia. ⁴University of California, Davis, USA. ⁵CMPG, Katholieke Universiteit, Heverlee, Belgium. ⁶Corresponding author*

Received 31 January 2002. Accepted in revised form 20 August 2002

Key words: expression analysis, expressed sequence tags, large-scale sequencing, molecular breeding, Phaseomics consortium, *P. vulgaris*, *Rhizobium*

Abstract

Globally, 800 million people are malnourished. Heavily subsidised farmers in rich countries produce sufficient surplus food to feed the hungry, but not at a price the poor can afford. Even donating the rich world's surplus to the poor would not solve the problem. Most poor people earn their living from agriculture, so a deluge of free food would destroy their livelihoods. Thus, the only answer to world hunger is to safeguard and improve the productivity of farmers in poor countries. Diets of subsistence level farmers in Africa and Latin America often contain sufficient carbohydrates (through cassava, corn/maize, rice, wheat, etc.), but are poor in proteins. Dietary proteins can take the form of scarce animal products (eggs, milk, meat, etc.), but are usually derived from legumes (plants of the bean and pea family). Legumes are vital in agriculture as they form associations with bacteria that 'fix-nitrogen' from the air. Effectively this amounts to internal fertilisation and is the main reason that legumes are richer in proteins than all other plants. Thousands of legume species exist but more common beans (*Phaseolus vulgaris* L.) are eaten than any other. In some countries such as Mexico and Brazil, beans are the primary source of protein in human diets. As half the grain legumes consumed worldwide are common beans, they represent the species of choice for the study of grain legume nutrition. Unfortunately, the yields of common beans are low even by the standards of legumes, and the quality of their seed proteins is sub-optimal. Most probably this results from millennia of selection for stable rather than high yield, and as such, is a problem that can be redressed by modern genetic techniques. We have formed an international consortium called 'Phaseomics' to establish the necessary framework of knowledge and materials that will result in disease-resistant, stress-tolerant, high-quality protein and high-yielding beans. Phaseomics will be instrumental in improving living conditions in deprived regions of Africa and the Americas. It will contribute to social equity and sustainable development and enhance inter- and intra-cultural understanding, knowledge and relationships. A major goal of Phaseomics is to generate new common bean varieties that are not only suitable for but also desired by the local farmer and consumer communities. Therefore, the socio-economic dimension of improved bean production and the analysis of factors influencing the acceptance of novel varieties will be an integral part of the proposed research (see Figure 1). Here, we give an overview of the economic and nutritional importance of common beans as a food crop. Priorities and targets of current breeding programmes are outlined, along with ongoing efforts in genomics. Recommendations for an international coordinated effort to join knowledge, facilities and expertise in a variety of scientific undertakings that will contribute to the overall goal of better beans are given. To be rapid and effective, plant breeding programmes (i.e., those that involve crossing two different 'parents') rely heavily on molecular 'markers'. These genetic landmarks are used to position

* FAX No: +41-2-2906-1741.

E-mail: william.broughton@bioveg.unige.ch

**With contributions from all members of the Phaseomics Consortium (see Appendix for details).

important genes (e.g. for resistance to particular pests, for yield, etc.) on a chromosome and ensure that they can be 'crossed in' to another plant. There are several ways of obtaining molecular markers but the project will establish partial sequences of messenger RNA's extracted from tissues of interest (e.g. developing pods). These so-called expressed sequence-tags (ESTs), can be used like milestones on a chromosome, to position these and other genes. These efforts will complement current studies on other legumes such as *Lotus japonicus* and *Medicago truncatula* as well as the EST projects in soybean by providing a framework for comparative genomics between legumes. Complete sequencing and molecular analysis of the bean genome will follow. Individual laboratories will be encouraged to internally finance or find additional funding for the construction of cDNA libraries and the sequencing of thousands ESTs. Funds donated to the consortium will be used primarily for sequencing the genome and to co-ordinate the consortium's activities. As sequence and expression data become available it will provide an elaborate framework for plant geneticists to 'design' new, improved common bean lines. Amongst these lines will be higher-yielding varieties, cultivars that are resistant to drought, pests and so on. It will also be possible to enhance the content of essential amino acids, minerals and vitamins in the seeds and so improve the nutrition and health of countless people who consume beans. By considering the socio-economic implications of common bean improvement from the outset, this project should lead to sustainable development, to increased social equity, and to greater use of beans in international trade. The added value in this innovative approach to common beans as model food legumes lies in the combination of existing and novel genetic approaches with socio-economic criteria that will efficiently target the end users.

Abbreviations: ACCase–Acetyl CoA Carboxylase; AHL–*N*-Acyl Homoserine Lactones; AFLP–Amplified Fragment Length Polymorphism; APA–Arcelin-Phytohaemagglutinin- α -Amylase (gene family); BAC–Bacterial Artificial Chromosome; BCMV–Bean Common Mosaic Virus; BGYMV–Bean Golden Yellow Mosaic Virus; BNF–Biological Nitrogen Fixation; BYMV–Bean Yellow Mosaic Virus; CBB–Common Bacterial Blight; Contigs–Contiguous groups of overlapping clones; cpDNA–chloroplast DNA; 2-D-PAGE–Two-Dimensional Polyacrylamide-Gel Electrophoresis; ESTs–Expressed Sequence Tags; FISH–Fluorescence *in situ* Hybridisation; GIMH–Genomic Interspecies Micro-array Hybridisation; HTP–High Throughput; ISR–Induced Systemic Resistance=SAR; ITS–Intergenic Transcribed Sequence; LRR–Leucine Rich Repeat; LD–Linkage Disequilibrium (analysis); OG–Oligo-Galacturonides; PCR–Polymerase Chain Reaction; %Ndfa is the amount of N derived from the atmosphere, expressed as a % of the total nitrogen in the plant [the rest is %N derived from soil (%Ndfs) and %N derived from fertiliser (%Ndff)]; PGPR–Plant Growth Promoting Rhizobacteria; PHA–Phytohaemagglutinin; Phaseomics–Genomics, transcriptomics and proteomics as applied to *Phaseolus* spp.; PG–Poly-Galacturonase; PGIP–Poly-Galacturonase Inhibiting Protein; PUE–Phosphorus Use Efficiency; MAS–Marker Assisted Selection; MT–Metric Tonnes; NBS–LRR–Nucleotide Binding Site–Leucine Rich Repeat; QTL–Quantitative Trait Loci; RAPD–Randomly Amplified Polymorphic DNA; RGAs–Resistance Gene Analogues; RILs–Recombinant Inbred Lines; RFLP–Restriction Fragment Length Polymorphism; RNAi–RNA interference=RNA silencing; SAGE–Serial Analysis of Gene Expression; SAR–Systemic Acquired Resistance=ISR; SCAR–Sequence Characterised Amplified Region; SNP–Single-Nucleotide Polymorphism; SSR–Simple Sequence Repeat; STS–Sequence Tagged Site; VAM–Vesicular Arbuscular Mycorrhizae; VIGS–Virus Induced Gene Silencing; WWW–see <http://www.phaseolus.net>

Economic and nutritional importance

Introduction

Beans (*Phaseolus* spp. L.) are one of the most ancient crops of the New World. Together with maize and cassava, they have been a dominant staple in the low to mid-altitudes of the Americas for millennia. Beans are extremely diverse crops in terms of cultivation methods, uses, the range of environments to which

they have been adapted, and morphological variability. They are found from sea level up to 3000 m above sea level, are cultivated in monoculture, in associations, or in rotations. Beans are consumed as mature grain, as immature seed, as well as a vegetable (both leaves and pods). Their genetic resources exist as a complex array of major and minor gene pools, races and intermediate types, with occasional introgression between wild- and domesticated-types.

Beans are thus a crop that is adapted to many niches, both in agronomic and consumer preference

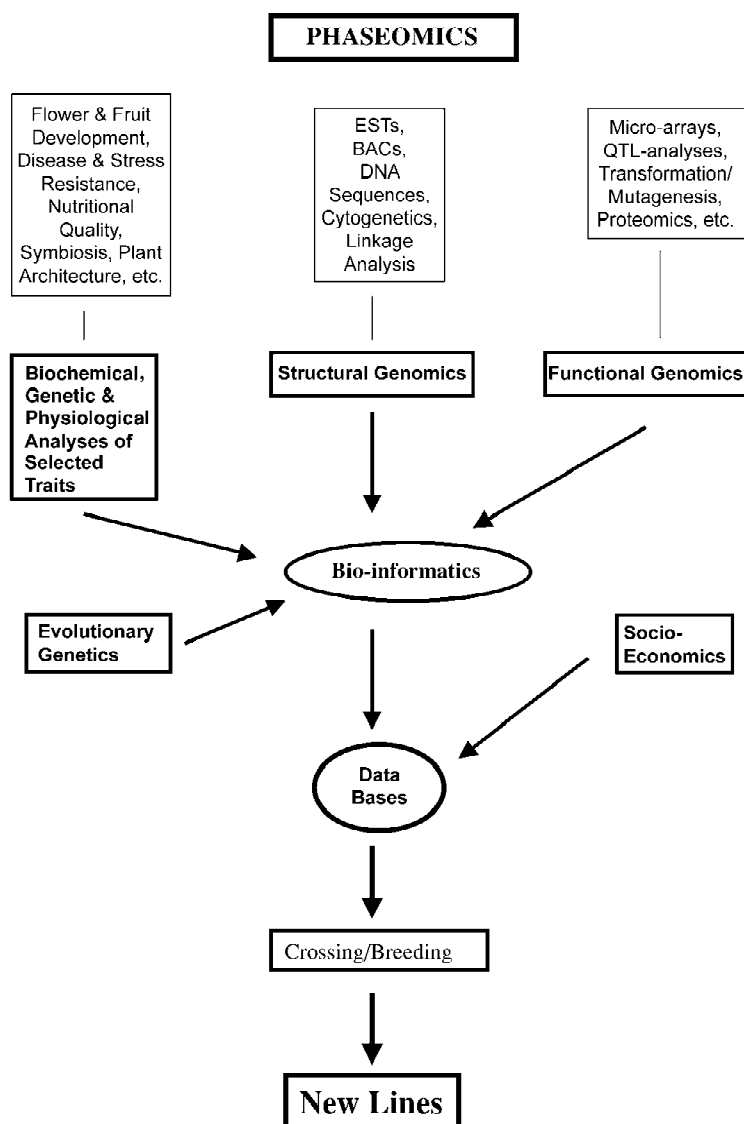

Figure 1. Flow-chart showing the relationships between the various components of Phaseomics.

terms. Since fruits (pods) can be obtained in as little as 2 months, rotations are possible with other crops during short growing seasons. Short bush growth habits offer minimal competition and permit inter-planting with other species, for example, in reforestation projects or among fruit trees or coffee plantations during the early years until the main crop can be exploited. At the other extreme, aggressive climbers are found at higher altitudes on subsistence farms where a few plants are maintained as a sort of insurance and are continually harvested for about 6 months. Over the past 20 years, beans have also been increasingly cul-

tivated on a commercial scale, and are now offered in national, regional and international markets.

Importance of beans

Production

Beans are the most important grain legumes for direct human consumption in the world. Total production exceeds 23 million metric tonnes (MT) (Tables 1,2), of which 7 million MT are produced in Latin America and Africa. Bean production is almost twice that of chickpea, which is the second most important grain legume. Social factors and ecological constraints

Table 1. Bean production in Latin America

Country/region	Area (ha × 10 ⁻³)	Production (MT × 10 ⁻³)
Brazil	5092	3055
Mexico	2259	1300
Central America (Guatemala, Honduras, El Salvador, Nicaragua, Costa Rica, Panama)	526	337
Southern Zone (Chile, Argentina, Paraguay)	357	398
Andean Zone (Venezuela, Colombia, Ecuador, Peru, Bolivia)	299	265
Caribbean (Cuba, Haiti, Dominican Republic)	157	141
TOTAL	8690	5496

determine whether beans are grown in a particular region. As agriculture and social systems have evolved together, the current state of farming systems is the result of the interaction of climatic, edaphic, biotic and social factors.

A large part of bean production in Latin America (Table 1) takes place on small farms ranging from 1 to 10 ha in size, often on sloping land of low fertility. Some estimates suggest that as much as 80% of the area planted with common beans in Latin America is found on hillsides. Moreover, these smallholdings are dispersed, making it difficult to define main production areas.

Except for Argentina, where most beans are produced on large holdings in modern production systems, small landholders usually cultivate beans in Latin America. In Brazil, about one-third of total bean output is produced on farms of less than 10 ha. In Mexico, an estimated 67% of production comes from even smaller farms (<5 ha). Even in Chile, which exports much of its production, beans are grown by some 50 000 farmers whose plots vary from 2 to 6 ha and a smaller number of medium-size growers who plant 20–30 ha. Regionally, more than half the production occurs on farms smaller than 20 ha and more than 20% on farms of less than 5 ha. The extreme cases are represented by countries like Haiti, the Lesser Antilles, and Paraguay where production is almost exclusively in the hands of small-farm families. In Mexico, Brazil, Chile and Cuba, it is possible to find small, medium and large-scale bean producers. Even in Brazil where large-scale agriculture has been widely promoted, only about 4% of the area and 15% of the bean production is derived from high input irrigated systems.

Beans are also a very important food crop in many parts of Eastern and Southern Africa with over four

Table 2. Bean production in Africa^a

Region	Area (%)	Area (ha × 10 ⁻³)
Eastern Africa – highland and mid-altitude (Burundi, DR Congo, Ethiopia, Kenya, Rwanda, Tanzania, Uganda)	62	2490
Southern Africa (Lesotho, Madagascar, Malawi, Mozambique, South Africa, Swaziland, Tanzania, Zambia, Zimbabwe)	31	1290
Western Africa (Angola, Cameroon, Cape Verde, Togo)	3	135
Lowlands-winter season (Algeria, DR Congo, Egypt, Mali, Malawi, Mauritius, Morocco, Nigeria, Sudan, Tunisia)	4	200
TOTAL	100	4025

^aModified from 'Atlas of Common Bean Production in Africa' (Wortmann et al., 1998).

million hectares produced in more than 20 countries (Table 2). As in Latin America, resource-poor farmers with very few inputs, grow beans primarily on small-scale, marginal farms. In Africa, women farmers, who have little access to fertiliser compared to men farmers, more often grow beans. Intercropping of beans with cereals (maize, millet or sorghum), bananas and plantains or root and tuber crops is common practice. Given these problems, it is not surprising that average yields are low. Much of the bean crop is lost to diseases as well as insect pests or drought, low soil-fertility and other abiotic stresses. Higher-yielding climbing beans have been adopted in some areas of greater population density. Many varieties of beans are grown in Africa, with notable diversity in seed types and adaptation. Local and market preferences as well as the variability in climatic and agronomic conditions generally dictate

Table 3. Per capita bean consumption in several Latin American and African countries – by region and/or economic strata where data are available

Country/region	Average annual consumption (kg)	Range over economic strata
Latin America		
Mexico	16+	
<i>Durango</i>	18**	10–26**
Honduras	13.0	11.2–15.9
Nicaragua	14	
Guatemala	10	
Costa Rica	11	
El Salvador	13.5	
Colombia	4.3*	
<i>Cali (lowest strata)</i>	9.8	
<i>Medellin</i>	12.8	11.5–14.3
Ecuador	6	
Bolivia		
<i>Sta. Cruz (urban)</i>	6	
<i>Sta. Cruz (rural)</i>	24	
Brazil	17.2	
<i>Southeast</i>	18.2	
<i>Northeast</i>	20.8	
Africa		
Kenya	12	
<i>Kisii</i>	66	
Rwanda	48	
Uganda	11	
<i>Mbale</i>	58	

+ High end value, although consumption fluctuates from 10 to 16 kg/yr as availability varies from year to year.

*Based on national production figures but ignoring importations.

**Estimated from reported family consumption.

which varieties are most popular. There is some bias towards the large-seeded types however, especially in the Great Lakes and highland regions of Eastern and Central Africa, where many farmers grow and maintain seed mixtures of all sizes and colours. The grain is an important cash-crop. Marketing of beans occurs locally and across established trade routes usually to urban areas within the same country of production. Bean leaves are also an important vegetable in parts of the African continent.

Consumption

It is commonly believed that demand for beans is income-inelastic, and that consumption drops as economic levels rise. Bean production in Latin America has increased by 3% per year over the past decade

however, which is well above the 1.7% population growth rate. As virtually all beans produced are consumed within the region, this suggests per capita consumption has increased modestly. Production has increased by 16% in the Andean zone demonstrating the potential of augmenting consumption through greater production. Bolivia is another case in point. Consumption in rural areas around Santa Cruz was low but since beans have become an important cash crop in the region, consumption has reached one of the highest levels in the Americas (24 kg yr⁻¹). Documentation of consumption through household surveys shows that it continues to be high in traditional bean consuming countries. For example, in Brazil, the two regions with the highest consumption are the northeast (20.8 kg yr⁻¹) and the southeast (18.2 kg yr⁻¹), which are, respectively, the least and the most developed regions. Those few cases in which consumption has been broken down into family incomes show that consumption in lower income strata is as much as 20% higher than average figures would indicate. In this sense, beans are the ‘poor man’s meat’ and play a particularly important role in the diet of the underprivileged. Available consumption data are presented in Table 3.

Beans are a major staple of eastern and southern Africa. In these areas, yearly bean consumption is as high or higher than in Latin America reaching up to 66 kg per person in some rural areas of Kenya. In both Rwanda and Burundi statistics show that the average national consumption exceeds 40 kg per person per year. Beans are estimated to be the second most important source of dietary protein and the third most important source of calories in the region. Beans are often combined with such energy sources as maize, plantains or root crops. The high nutritional quality of beans in terms of percentage protein is an important complement to these starchy foods. In addition the high mineral content of beans, especially of iron and zinc, are advantageous in regions where there is a high prevalence of micronutrient deficiencies such as iron deficiency anemia.

Dietary proteins

Beans provide dietary proteins that play an essential role in human nutrition by complementing other foods (e.g., maize in the Latin American highlands and Eastern Africa and rice in Brazil) that are primarily sources of carbohydrates. Bean seeds contain between 20 and 25% proteins, much of which is made up of the storage protein phaseolin (Ma and Bliss, 1978). Phaseolin is a major determinant of both quantity and nutritional

quality of proteins in bean seeds (Bliss and Brown, 1983; Gepts and Bliss, 1984). Like other seed proteins of the legume family, phaseolin is deficient in sulphur-containing amino acids such as methionine. Seed proteins of cereals generally contain sufficient sulphuryl amino acids but are themselves deficient in other essential amino acids such as lysine. Combined consumption of cereals and legumes generally alleviates these mutual deficiencies ensuring a balanced diet when cereals and legumes are consumed in the ratio of 2:1 (Bressani, 1983). Unfortunately, this is seldom the case as legume yields are generally low. Thus, increasing legume yields has important repercussions on improving nutrition and health of hundreds of millions of bean consumers in the world, especially in developing countries.

Vitamins and minerals

Vitamins Biotin is an essential cofactor for a variety of carboxylases and decarboxylases found in diverse metabolic pathways of all organisms (Knowles, 1989). It plays a central role in membrane biogenesis, catabolism of some amino acids and the production of oxaloacetate. Despite this ubiquitous requirement for biotin, its *de novo* synthesis is restricted to plants and some microbes. In order to meet the daily requirement in the human diet, the vitamin is routinely added to fruit juices and other food products. It is also added to many health care and cosmetic products. A major part of the biotin produced is used directly to increase the biotin contents of livestock and other animal feeds. Most of the biotin commercially available is currently synthesised in a chemical process that is complex (comprising 13 steps), requires large energy inputs and generates considerable waste. An alternative way of supplementing dietary biotin would be through the development of plants, fruits and seeds with high biotin contents.

Preliminary data suggest that the biotin status varies among plants, during the stage of development and with conditions of growth. Accordingly, the isolation, identification and characterisation of the *bio*-genes of *P. vulgaris* will widen our understanding of the optimal conditions and of the most suitable plant tissue for obtaining large amounts of free biotin. Inclusion of these foods in human and livestock diets would provide important benefits for general health.

Recent evidence suggests that the biotin biosynthetic pathway may be very similar in plants and bacteria (reviewed by Streit and Entcheva, 2003) and includes:

Table 4. Mineral contribution of beans assuming 15 kg per capita annual consumption

Nutrient	Content of average daily serving (125 g cooked)	Adult male requirement (mg)	% Adult requirement in one serving
Sodium	0 mg	2200	0
Potassium	475 mg	3900	12
Calcium	65 mg	800	8
Phosphorus	161 mg	800	20
Magnesium	56 mg	350	16
Iron	2.78 mg	10	27
Zinc	1.24 mg	15	8
Copper	0.307 mg	2.5	12
Manganese	0.668 mg	3.75	18
Selenium	0.002 mg	0.05–0.2	1–4
Iodine	0.032 mg	150	0
Starch	22.1 g	570 g (2750 kcal.)	4
Protein	8.5 g	69 g	12

Adapted from Pennington and Young (1990a,b) and Robinson (1987).

- All the known bacterial intermediates of biotin synthesis including the novel metabolite 9-mercaptodethiobiotin, have been found in plants (Baldet et al., 1993a, 1997).
- Two embryo-arrested mutants of *Arabidopsis thaliana* were found to be biotin auxotrophs: the *biol* mutant is defective in DAPA aminotransferase (Schneider et al., 1989) and could be complemented by the *E. coli bioA* gene (Patton et al., 1996a); the second *Arabidopsis* mutant, *bio2* was found to be defective in the final step of biotin synthesis, i.e., the conversion of dethiobiotin to biotin (Patton et al., 1998). Furthermore, a cDNA clone encoding an *A. thaliana* homologue of the bacterial *bioB* has been isolated (Patton et al., 1996b; Weaver et al., 1996). In general, bacteria use all of their biotin to biotinylate biotin-containing proteins (Cronan, 1989), whereas, plants accumulate most of their biotin as the protein-free molecule (Baldet et al., 1993b; Shellhammer and Meinke, 1990; Wang et al., 1995). In pea leaves, the free biotin pool in the cytosolic compartment accounts for 90% of the total (free plus protein-bound) biotin (Baldet et al., 1993a). Biotin synthesis may thus occur in the cytosol (Baldet et al., 1993b; Shellhammer, 1990).

Minerals Most measures of health in the developing world have shown gradual improvement over

the last 50 years. Micronutrient deficiencies (especially iron) have become more common however, even in developed countries. Cereals normally make up the bulk of diets composed of basic grains and supply the greater energy component. Legumes on the other hand contribute more of the other components of diet. Legumes are much superior to cereals as sources of micronutrients (Welch et al., 2000) first because legumes have a higher initial content of minerals, and second since many cereals are polished before eating (for production of white rice or wheat flour for white bread, etc.). As a significant proportion of the minerals are found in the seed coat (or bran) they are discarded during processing. Most legumes, including common beans, are consumed whole. As a result their mineral content is conserved. Consumption of beans in Latin America thus represents a significant contribution to human nutrition. Beans are an important source of iron, phosphorus, magnesium, manganese, and in lesser degree, zinc, copper and calcium (Table 4). At levels of consumption commonly found in people of restricted economic means (15–20 kg yr⁻¹), beans provide 10–20% of the adult requirement for a number of nutrients.

Culinary and nutritional quality

Unfortunately, the culinary and nutritional quality of many bean varieties leave much to be desired. Generally, bean seeds need to be soaked and must be cooked to render them palatable. Cooking inactivates heat-labile anti-nutritional compounds as well as permits the digestion and assimilation of proteins and starch (Kigel, 1999). Cooking beans also solubilises the proto-pectin within the middle lamella forming soluble pectin that depolymerises rapidly during heating, allowing water to enter cells of the cotyledon (Stanley and Aguilera, 1985). Modifying the composition of the middle lamella may thus render bean seeds easier to cook (see Table 8, p. 75).

Flatulence in humans is often the result of ingesting foods high in raffinose, stachyose and verbascose. Although these sugars are indigestible, micro-flora of the lower intestine ferment them producing gas (Kigel, 1999). As considerable variability among various bean genotypes for their propensity to induce flatulence exists, it seems likely that molecular breeding programmes should help alleviate this problem (Table 8).

Anti-nutritional factors are present in the seeds of many legumes. Amongst them are α -amylase inhibitors, arcelins, lectins, phytates, phenolic sub-

stances and tannins (Kigel, 1999). Tannin contents change with seed colour. The anti-nutritive properties of phytates stem from their ability to chelate calcium, iron, magnesium and zinc. A multi-gene family encodes lectins. Interestingly, although arcelins and α -amylase inhibitors render bean seeds less palatable, they serve protective functions in the fruit. Arcelins and α -amylase inhibitors have insecticidal properties, while α -amylase inhibitors confer resistance to bruchid beetles since these glycoproteins are toxic to their larvae (Shade et al., 1994). Thus, given the wide-variations present in the gene pools, breeding for lower contents of anti-nutritional compounds should be possible in beans. It is necessary however, to avoid weakening the plant by decreasing some of its protective functions.

Phytic acid Phytic acid is the main seed storage molecule for phosphorous. Phytic acid is necessary for normal seed development and germination although its concentration in different bean varieties is variable (Lolas and Markakis, 1975). Phytic acid (myo-inositol hexaphosphate) and its salts (phytates) represent between 54 and 82% of the phosphorous content of the bean i.e. between 0.5 and 1.6% of the seed weight (Lolas and Markakis, 1975). Embryogenesis continues up to 36 days but the peak accumulation is between 24 and 30 days, which normally coincides with the high level of inorganic phosphorous in the cotyledon (Walker, 1973). Walker (1973) also showed that phytase was undetectable during the same period and that the activity of this enzyme was first measurable two days after germination.

Phytic acid chelates various divalent metal ions and is implicated in their reduced absorption leading to deficiency symptoms in animals and humans in diets predominated by legume seed proteins (Sandberg et al., 1993). The catabolism of phytate is controlled by phytase and some other acid phosphatases that allow the phosphorous to be assimilated. Without these enzymes, phytate passes through the intestinal system without being degraded, so contributing to the P load of the resulting manure (Lott et al., 2000). This is already becoming a problem in Europe and North America, where it accelerates the eutrophication of waterways and reservoirs. On the other hand, recent research has revealed the possible therapeutic properties of phytate in the prevention of cancers of the breast and colon, probably due to its anti-oxidant properties. Phytate has also been implicated in the reduction of cholesterol and other lipids due to its

presence in high fibre diets (Midorikawa et al., 2001; Reddy, 1999; Shamsuddin et al., 1997; Thompson and Zhang, 1991).

Various phytic acid mutants have been described in the literature for rice, Larson et al. (2000), maize, Raboy et al. (2000) and wheat, Raboy et al. (1991). Basically, a reduction in the phytate content was observed in all the mutants but the overall concentration of phosphorous was not reduced and was compensated by a corresponding increase in the inorganic phosphorous content. Analysis of the levels of phytic acid and total protein content of the seeds revealed that there exists a positive correlation between these two variables (Raboy et al. 1991). The authors suggest that a selection for low phytic acid could result in undesirable reductions in the protein level.

Economics of bean production

Cost analysis

Much poverty in Africa and Latin America is found in rural areas, and thus the success of agriculture is a central issue in ameliorating living conditions. Legumes in general are considered to be relatively profitable crops compared to other options such as cereals, and beans are no exception. For example, in Brazil, large-scale farmers who recover their investment on irrigation systems count on beans for a quick profit. In Central America small farmers report that among the traditional field crops, beans are the best income generator. Recent cost analyses of bean production confirm that beans remain profitable. In Nicaragua, farmers were separated into two groups; those using a landrace variety and those using an improved variety. Unsurprisingly, farmers using the improved variety enjoyed much greater profits (\$390 vs. \$136 ha⁻¹) that are due to higher yields. Thanks to these higher yields, production would still be profitable even if prices were 40% lower.

In Colombia, large-seeded Andean types are preferred because they command better prices and higher profits than the small-seeded types used in Central America. Small farmers in the Santander department earned from US\$960 to \$1153 ha⁻¹ yr⁻¹ (over two production seasons) with improved varieties compared to \$260 ha⁻¹ yr⁻¹ earned with the local cultivar Radical. Again, increased income was due largely to higher yields. Immigrant families from the Sierra have colonised the eastern plains of Bolivia that previously enjoyed only one planting season per year. Winter was a time of want and migration to other regions to seek

work. Introduction of Brazilian types of beans for export offered the possibility of winter cultivation that has been widely accepted. Although these grain types earn lower prices than the traditional varieties, net incomes were estimated at \$113 ha⁻¹, (or \$248 when family labour is not counted). Given that a farmer would otherwise have to abandon his home for several months, the higher figure reflects more accurately the value of the bean crop. Farmers attribute their improved wellbeing to income from beans, and cite such additional benefits as improved nutrition for the family as well as increased educational opportunities for their children.

Globalisation

The past decade has seen the development of an international market for beans that now exceeds 2.4 million MT. According to the Food and Agricultural Organisation of the United Nations (FAO), China and Myanmar are the largest exporters (19% each of total exports!) but part of this volume undoubtedly represents other legumes. Nonetheless, these two countries stand out for their low costs of production. Other important exporters include the United States (18%), Argentina (12%) and Canada (6%). Within Latin America, Mexico, Brazil, Venezuela and Cuba are major importers. Costa Rica, a traditional bean producer, now imports 50% of the beans consumed. At present the most widely traded cultivars are pinto and black beans, but other classes may be produced shortly for markets such as Central America. In a very real sense, this represents a challenge to both large and small producers in the developing world, and draws them directly into the arena of world competition. Competition heightens the problems of small bean producers that have few other sources of income. Thus, competitiveness is a major concern for bean production in Latin America, and in most cases must be met by higher yields. In a study of competitiveness by Hertford and Garcia (1999) of several crops in Latin America, beans were found to be reasonably competitive across most of the region (with notable exceptions of Mexico and Brazil, which probably have large internal differences in competitiveness). Argentina was by far the most competitive of all bean-producing countries. Guatemala was generally a very poor competitor in agriculture, but beans are one of the few crops in which it did well. In Africa, most trade in beans is within a single country or informally between countries. As a result, imports are generally small.

Table 5. Grain legumes: tribal affiliations, genome organisation and world production^a

Vernacular name	Latin name ^b (Sub-family – Papilionoideae)	Tribe	Ploidy level ^c	Chromosome # (n) ^c	1C DNA content ^c	Production (MT × 10 ⁶) ^d
Soybeans	<i>Glycine max</i> (L.) Merrill	<i>Phaseoleae</i>	2	20	1110	177.32
Peanuts/groundnuts	<i>Arachis hypogaea</i> L.	<i>Aeschynomeneae</i>	4	20	1740	34.70 ^e
Common beans	<i>Phaseolus vulgaris</i> L.	<i>Phaseoleae</i>	2	11	590	22.57 ^f
Peas	<i>Pisum sativum</i> L.	<i>Vicieae</i>	2	7	4560	17.68 ^g
Chick peas/garbanzo	<i>Cicer arietinum</i> L.	<i>Cicereae</i>	2	18	930	6.00
Broad/faba beans	<i>Vicia faba</i> L.	<i>Vicieae</i>	4	12	26 850	4.24 ^h
Lentils	<i>Lens culinaris</i> Medik.	<i>Vicieae</i>	2	7	4120	3.39
Long beans/cowpeas	<i>Vigna unguiculata</i> (L.) Walp.	<i>Phaseoleae</i>	2	11	590	3.04
Egyptian/white lupins	<i>Lupinus albus</i> L.	<i>Genisteae</i>	2	?	590	1.69 ⁱ
Yellow lupins	<i>Lupinus luteus</i> L.	<i>Genisteae</i>	2	26	980	na
Pearl lupins	<i>Lupinus mutabilis</i> sweet	<i>Genisteae</i>	na	na	na	na
Carobs	<i>Ceratonia siliqua</i> L. (sub-family – Caesalpinioideae)	<i>Cassieae</i>	2	12	na	0.23
Bambara groundnuts	<i>Vigna subterranea</i> (L.) Verdc.	<i>Phaseoleae</i>	2	1	880	0.03
Lima beans	<i>Phaseolus lunatus</i> L.	<i>Phaseoleae</i>	2	11	690	na
Scarlet runner beans	<i>Phaseolus coccineus</i> L.	<i>Phaseoleae</i>	2	11	670	na
Year beans	<i>Phaseolus coccineus</i> L. subsp. <i>polyanthus</i> (Greenman) Maréchal, Mascherpa and Stainer	<i>Phaseoleae</i>	2	11	na	na
Tepary beans	<i>Phaseolus acutifolius</i> A. Gray	<i>Phaseoleae</i>	2	11	740	na
Mung beans	<i>Vigna radiata</i> (L.) Wilczek	<i>Phaseoleae</i>	2	11	520	na
Urd	<i>Vigna mungo</i> (L.) Hepper	<i>Phaseoleae</i>	2	11	540	na
Adzuki beans	<i>Vigna angularis</i> (Willd.) Ohwi and Ohashi	<i>Phaseoleae</i>	2	11	540	na
Rice beans	<i>Vigna umbellata</i> (Jacq.) Ohwi and Ohashi	<i>Phaseoleae</i>	2	11	570	na
Moth beans	<i>Vigna aconitifolia</i> (Jacq.) Maréchal	<i>Phaseoleae</i>	2	11	1110	na
Winged beans	<i>Psophocarpus tetragonolobus</i> (L.) DC	<i>Phaseoleae</i>	2	9	780	na
Hyacinth beans	<i>Lablab purpureus</i> (L.) sweet	<i>Phaseoleae</i>	2	na	na	na
Kersting's groundnuts	<i>Macrotyloma geocarpum</i> (Harms) Maréchal and Baudet	<i>Phaseoleae</i>	2	na	na	na
Jack beans	<i>Canavalia ensiformis</i> (L.) DC	<i>Phaseoleae</i>	2	11	na	na
Sword beans	<i>Canavalia gladiata</i> (Jacq.) DC	<i>Phaseoleae</i>	2	11	na	na
Yam beans	<i>Pachyrhizus tuberosus</i> (Lam.) A. Spreng.	<i>Phaseoleae</i>	2	11	na	na
Pigeon peas	<i>Cajanus cajan</i> (L.) Millsp.	<i>Cajaninae</i>	2	11	860	na

^aThe table was adapted from Debouck (1991); ^bSee Pueppke and Broughton (1999); ^cData from Bennett and Leitch (2001) and Smartt (1990); ^dSee Food and Agriculture Organization of the United Nations (2001); ^eIncludes shells; ^fIncludes dry, green and string beans; ^gIncludes green and dry peas; ^hIncludes dry and green broad beans; ⁱTotal for all *Lupinus* spp.

Exploiting niches

One possibility for maintaining competitiveness is the exploitation of market niches that are too specialised for large producers or international markets. Exploitation of grain diversity is one such possibility in many countries. Specialty grains often fetch high prices, such as Bolón Amarillo in Ecuador; the Rosinha type in Brazil; the Flor de Mayo type in Mexico; Cargamanto in Colombia; and the Kablanketi type in Tanzania. Yet another option in the Andean environment is the Nuña or popping bean. This unusual relic

of the high Andes adapts poorly to other environments and thus the potential for competition is restricted. Markets must still be developed and marketing infrastructures established however. Snap beans are an important, high value, labour-intensive crop of small farmers in the Andean zone. Although pesticide abuse is often associated with this crop, snap beans are also a promising niche crop.

Of course higher value crops also carry risks that include large fluctuations in price as well as the need to be sold rapidly. Quality and limited storage life of-

ten result in excessive pesticide use (e.g., with snap beans). Access to the necessary infrastructure that includes markets is another limitation, especially for small farmers who are familiar with their traditional bean varieties.

Genetic improvement

Phylogeny

The legume family (Leguminosae) is very large with 643 genera (18 000 species) grouped into 40 tribes that are found in both tropical and temperate environments (Lavin et al., 1990; Mabberley, 1998; Pollhill, 1981, 1994). The tribe *Phaseoleae* [common beans (*P. vulgaris*), long-beans/cowpeas (*Vigna unguiculata*), and soybeans (*Glycine max*)] is by far the most important economic group, and contains 75% of the legumes traded in the world (Table 5). Other tribes including *Aeschynomeneae* [peanuts (*Arachis hypogaea*)], the galeoid group that contains the *Cicereae* [chickpeas or garbanzo (*Cicer arietinum*)], *Trifolieae* [alfalfa (*Medicago sativa*), lentils (*Lens culinaris*), peas (*Pisum sativum*), and *Vicieae* [field beans (*Vicia faba*)] are also widely cultivated. Of these tribes, only those of the galeoid group are temperate. As the tropical and temperate tribes diverge markedly it remains to be demonstrated whether a legume such as *Medicago truncatula*, which is touted as a model species for the entire legume family, can reach across this divide and provide useful information relevant to tropical grain legumes. Co-linearity or synteny among all legume genomes is essential if one legume is to serve as the model for all others. Although high-levels of synteny have been found in the *Trifolieae* (Weeden et al., 1992) as well as amongst diploid species of the *Phaseoleae*, co-linearity is much less evident with more distantly related genera such as soybeans (Boutin et al., 1995). It is thus too early to say whether the extensive synteny found in the Gramineae (Benetzen and Freeling, 1997) also applies to legumes, highlighting the need to study nodal species in the Leguminosae, including *P. vulgaris*. In addition to food plants such as beans, long-beans, pigeon peas, soybeans, jícama (*Pachyrhizus erosus*), and several locally important species such as Bambara groundnut (*Vigna subterranea*), this tribe also contains forage and ornamental species. Thus, a co-ordinated and integrated genomics/transcriptomics/proteomics programme in the economically most important legume

species will have valuable repercussions on other species of the same tribe.

In recent years, several studies have clarified the phylogenetic relationships among *Phaseolus* species in general, and *P. vulgaris*, in particular. Studies on cpDNA (Delgado-Salinas et al., 1993) and ITS sequences (Delgado-Salinas et al., 1999) have established a phylogeny for the entire genus. A basal species has been identified, *P. microcarpus*. *P. vulgaris* belongs to a complex of species, that include *P. acutifolius*, *P. coccineus*, and *P. polyanthus*. Molecular data have thus confirmed that all these species can be inter-crossed, although the degree of difficulty and the viability of reciprocal crosses vary (Hucl and Scoles, 1985; Waines et al., 1989). Remarkable diversity of morphology occurs within this group of species (bushes to climbers, seed colour and colour patterns), adaptation (from hot deserts to cool mountain environments), and reproductive systems (from cleistogamy to out-crossing). In this sense too, the *P. vulgaris* complex provides a model to study the molecular basis of agronomically important phenotypes among closely related lines.

Intra-specific organisation of genetic variation in *P. vulgaris* has been well studied. A nucleus of diversity is located in Ecuador and northern Peru (Coulibaly, 1999; Kami et al., 1995), from which wild beans dispersed both northwards and southwards to form two geographically distinct gene pools in Mesoamerica and the southern Andes (reviewed in Gepts, 1998). In turn, post-domestication divergence gave rise to three domesticated races in each of these two gene-pools (Singh et al., 1991; see Figure 2).

These geographically distinct gene-pools qualify as sub-species based on the existence of partial reproductive isolation between them. Pairs of complementary genes that influence either the F₁ (dominant alleles) or later generations (recessive alleles) are genetically responsible for the isolation (Gepts and Bliss, 1985; Koinange and Gepts, 1992; Shii et al., 1981; Singh and Molina, 1996). Furthermore, it has often been difficult to obtain high-yielding genotypes in Andean×Mesoamerican crosses because of outbreeding depression (Beaver and Kelly, 1994; Johnson and Gepts, 1999; Kelly et al., 1998; Welsh et al., 1995). Preliminary estimates show a divergence time of some 500 000 years between these two gene-pools (Coulibaly, 1999). Thus, *P. vulgaris* is, at this stage, unique among crops in that two evolutionary lineages tracing back to the same ancestral populations have been identified. Similar information for other species

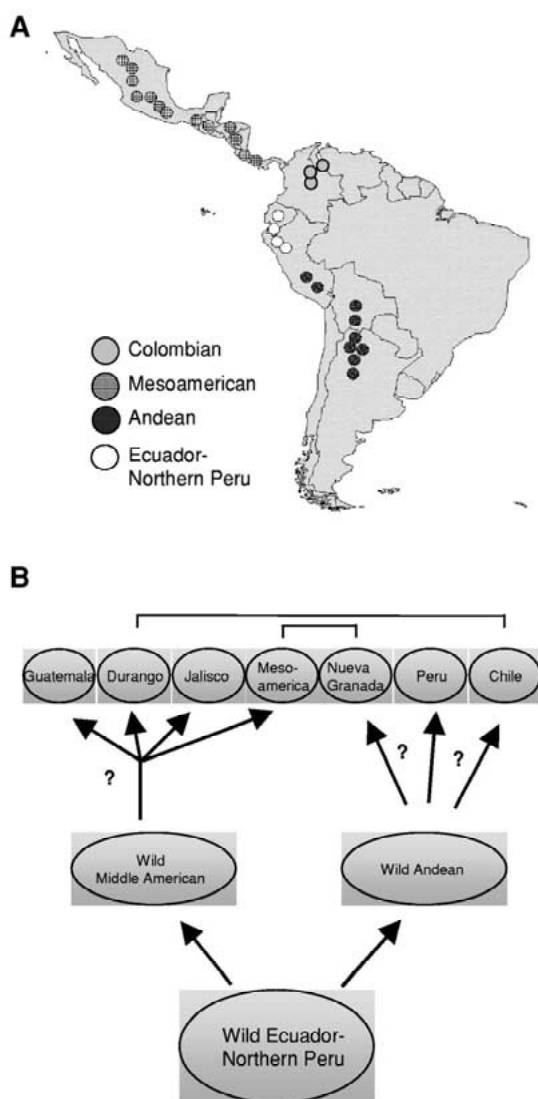

Figure 2. Distribution of wild *P. vulgaris* L. in Latin America. (A) It is possible to distinguish four centres of diversity: the Andean, the Colombian, the Ecuadorian/Northern Peru, and the Meso-American. In addition, important secondary centres of diversity exist in Africa, Brazil, Europe, the Middle East, as well as North America. (B) Domestication of the Andean- and middle American-gene pools lead to four races in the Middle Americas and three races amongst the Andean gene-pool. Introgression between genotypes representing the various races is shown [adapted from Beebe et al. (2000) and Gepts (1998)].

that also present two major gene pools is not available [rice (*Indica* and *Japonica*) and chickpea (*Kabuli* and *Desi*)].

Inter-specific hybridisation among Phaseolus species

Several steps are necessary in an interspecific hybridisation programme. These include: (i) accumulation of a very large germplasm; (ii) identification of the materials and comprehension of their genetic organisation; (iii) evaluation of the collection for the most useful agronomic traits; (iv) development of interspecific hybrids; and (v) breeding and release of high-performing interspecific lines that are sufficiently stable (Baudoin, 2001).

The genus *Phaseolus* is Neotropical in origin (see p. 64). Although we know clearly what a bean is, it is less certain how many *Phaseolus* species exist. A reasonable estimate would be 50–60 species, pending additional germplasm explorations in Central America (Debouck, 2000). Understanding the relationships between the species is a question of practical importance in the search for increased variability. Recent phylogenetic studies that included both wild and domesticated species of *Phaseolus* using morphological, biochemical and molecular data (seed proteins, isozymes and nuclear, chloroplastic and mitochondrial DNA, etc.) have confirmed that the genus is monophyletic (Debouck, 1999). Two to nine sub-clades may exist at the sub-generic level (Baudoin et al., 1998; Delgado-Salinas et al., 1999). One lineage includes the common bean while another encompasses *P. lunatus* (Fofana et al., 1999, 2001; Maquet et al., 1999). Three species, *P. coccineus*, *P. polyanthus*, and *P. vulgaris* belong to the same evolutionary branch (Schmit et al., 1993, 1995). Differences emerge however, between the number, kind of taxa and type of DNA examined. As further germplasm becomes available through explorations and as work with molecular markers progresses, a better definition of these relationships is expected.

Of the 50–60 wild *Phaseolus* species of American origin only five, namely, common (*P. vulgaris*), year-long (*P. polyanthus*), scarlet runner (*P. coccineus*), tepary (*P. acutifolius*), and Lima bean (*P. lunatus*) have been domesticated. Each domesticated species constitutes a primary gene pool with its wild ancestral form. Secondary and tertiary gene pools may exist for all the domesticated species, depending on the phylogenetic events that lead to the formation of the biological species (Debouck, 1999). Recently, a novel wild species, *P. costaricensis* was shown to belong to the secondary gene pool of *P. vulgaris*. *P. costaricensis* is only known from Costa Rica and Panama. There are over 29 000 domesticated and more than 1300 wild accessions of *P. vulgaris* housed in the germplasm bank at CIAT,

Cali, Colombia, and elsewhere (pp. 88–89). At CIAT, the numbers of accessions belonging to the secondary and tertiary gene pools, respectively, are 1049 and 335. In spite of this diversity, the genetic base of commercial cultivars of specific market classes is narrow. In fact, only a small portion (<5% of the available genetic diversity) has been used globally despite nearly a century of organised bean improvement.

Systematic evaluation of wild common bean as well as wild and domesticated germplasm of alien species for resistance to pests, diseases and other useful traits has been limited. Nevertheless, alien germplasm seems to be a promising source of common bean improvement as resistance to bruchids was found in wild *P. vulgaris*. *P. polyanthus* is well known for its resistance to ascochyta blight as well as to BGYMV (Bean Golden Yellow Mosaic Virus). *P. costaricensis* might also be a source of BGYMV resistance genes. *P. coccineus* is a source of resistance to anthracnose as well as root rots, white mold, BYMV (Bean Yellow Mosaic Virus) and BGYMV. Tolerance to leaf-hoppers exists in *P. acutifolius*, and high levels of resistance to CBB (Common Bacterial Blight) and bruchids are found in some accessions of tepary bean (Baudoin, 2001; Debouck, 1999; Schmit, Baudoin, 1992; Singh, 1999).

Thus, major production constraints, lack of resistance to diseases/pests, as well as slow progress in identifying useful genes in related species have led to the widespread adoption of interspecific hybridisations among *Phaseolus* species. From 1940 to 1985, *P. vulgaris* and *P. coccineus* were frequently intercrossed. It was observed however, that in reciprocal crosses using *P. coccineus* as the female parent, segregants naturally reverted to the cytoplasm donor parent after a few generations (Baudoin et al., 1995). Major genes have established a barrier between these two species, and chromosome pairing is not perfect. Since reproductive isolation may be due to domestication, attempts were made to cross *P. vulgaris* with wild variants of *P. coccineus*. Nevertheless few commercial cultivars have been created this way. *P. polyanthus* crosses more easily with *P. coccineus* and related forms than with *P. vulgaris*, particularly if the latter is the pollen donor (Baudoin et al., 2001). *P. polyanthus* belongs to the *P. vulgaris* clade, but its nuclear genome has been introgressed with *P. coccineus* genes and this limits its use in interspecific hybridisations. Especially when *P. vulgaris* is used as the female parent, crosses between *P. vulgaris* and *P. costaricensis* are simple to perform without embryo rescue, but it is not clear whether *P. coccineus* genes have contaminated the

nuclear genome of *P. costaricensis* (Debouck, 1999). *P. coccineus* and its allies may thus be the reservoir of diversity with greatest potential once the primary gene pool and the *P. vulgaris* phylum have been fully exploited.

'Congruity backcrosses' coupled with the careful choice of donor parents amongst *P. vulgaris* and *P. acutifolius* (a species belonging to the tertiary gene pool of *P. vulgaris*) accessions are a promising new method of improvement (Mejia-Jiménez et al., 1994). Nonetheless, embryo rescue techniques are needed and F₁ hybrids are completely male-sterile. *P. filiformis* and *P. angustissimus* have also been crossed with common bean but rescued hybrid plants were completely sterile (Baudoin, 2001). Chromosome doubling has been attempted to overcome incompatibility barriers but may not be very useful given the difficulty of exploiting amphidiploids. *P. parvifolius* crosses easily with *P. acutifolius*, and has been crossed with *P. vulgaris* (using embryo rescue). In spite of this work, its potential usefulness for common bean improvement has yet to be determined. An unrealised dream of combining the potential of Lima bean (part of the quaternary gene pool) that is well adapted to tropical conditions, with the genome of the common bean has failed to produce fertile hybrids. The reciprocal cross, *P. lunatus* × *P. vulgaris* was even less successful, confirming the taxonomic positions of common and Lima beans in the genus (Baudoin et al., 1995).

The major reproductive barrier to interspecific hybridisation amongst the genus *Phaseolus* occurs post-fertilisation, especially during early embryo development (Baudoin et al., 1995). When maintained *in vivo*, embryos resulting from *P. polyanthus* (female) × *P. vulgaris* crosses develop poorly despite the close phylogenetic relationship of these species. Infertility in *P. polyanthus* × *P. vulgaris* crosses results from early nutritional barriers that are related to a deficient endosperm tissue development while in reciprocal crosses, endothelium proliferation, and to some extent, hypertrophy of the vascular elements are causes of early embryo abortion (Geerts, 2001; Geerts et al., 1999, 2002; Lecomte et al., 1998). To a large extent, the importance of these abnormalities depends on the compatibility between the genotypes used as parents. Although several hybrids between *P. vulgaris* and species belonging to its tertiary gene pool can only be obtained by embryo rescue, most infertility results from male sterility which is caused by incomplete chromosomal pairing in Metaphase I (Baudoin et al., 1995). Where sterility of hybrids precludes any form of in-

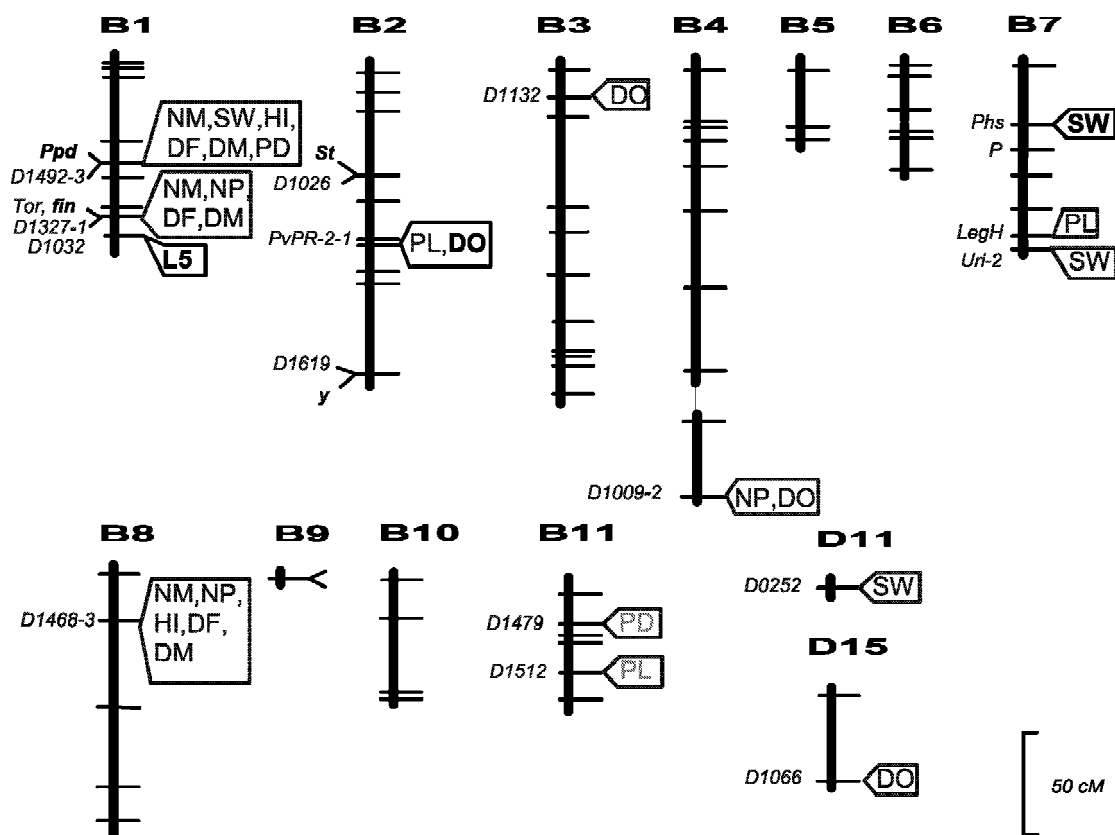

Figure 3. Chromosomal location of genes involved in the domestication syndrome in beans. Genes in bold are those that are presumably important in a conversion programme: *Ppd* – photoperiod sensitivity; *fin* – determinancy; *St* – presence of pod suture fibres; DO: QTL for seed dormancy; SW: QTL for seed weight (after Gepts, 1999b).

gression, traditional chromosome doubling yields weak semi-fertile amphidiploids.

It is thus not surprising that attempts to transfer polygenetic traits from related species to *P. vulgaris* met with limited success. Yet, less than 5% of the *Phaseolus* germplasm has been used in hybridisation programmes. New ways of enhancing introgression (congruity backcrossing, single seed descent, and recurrent selection) promise to restore fertility, as well as to augment the frequency of desirable genes in the breeding population. Phaseomics, by increasing the availability of molecular markers, by developing more detailed linkage maps, coupled with marker-assisted selection will facilitate the retention of desirable genes, the elimination of harmful ones and remove restrictions on inter-specific hybridisations.

Specific traits

Domestication

The domestication history of the common bean is well known and its wild progenitor has been identified (reviewed in Koinange et al., 1996). Wild progenitor and cultivated descendants generally give viable and fertile progeny and display contrasting differences for many traits constituting the crop domestication syndrome. The two most important attributes of the domestication syndrome in common bean are the loss of seed dispersal ability and seed dormancy because they are crucial for adaptation to a cultivated environment. The former is conditioned by the presence of fibres in the pods, both in the sutures ('string') and the walls. Loss of these fibres leads to indehiscence of the pods and lack of seed dispersal at maturity. Cultivated beans display a more compact growth habit compared to their wild progenitors. In its most evolved form under domestication, this growth habit is characterised

Table 6. Overview of mapping populations with their segregating characters, cited in the text

Population (generation)	Abbrev.	Traits segregating	Source
BAT93×Jalo EEP558 (F ₂)	BJ	Resistance to: Bean Common Mosaic Virus, <i>Xanthomonas axonopodis</i> ,	Gepts et al., 1993; Nodari et al., 1993
BAT93×Jalo EEP558 (RI)	BJ	<i>Colletotrichum lindemuthianum</i> , <i>Phaeoisariopsis griseola</i> , <i>Uromyces appendiculatus</i> , <i>Rhizobium</i> spp.	Freyre et al., 1998
Midas×G12873	MG	Domestication syndrome: <i>Ppd</i> , <i>fin</i> , <i>St</i> , <i>y</i> , <i>P</i> ; phenology, number of nodes and pods, seed weight; dormancy	Koinange et al., 1996
XR235-1-1×DIACOL Calima (BC)	XD	Resistance to: <i>Xanthomonas axonopodris</i>	Vallejos et al., 1992 Yu et al., 1998
Corel×EO2 (BC)	CE	Resistance to: <i>Colletotrichum lindemuthianum</i> ; <i>Ms-8</i> , <i>SGou</i>	Adam-Blondon et al., 1994
BAC6×HT 7719 (RI)	BH	Common bacterial blight, web blight, rust	Jung et al., 1996
Dorado×XAN176 (RI)	DX	Ashy stem blight, BGYMV, common bacterial blight, rust	Miklas et al., 1996; 2000a
PC-50×XAN-159 (RI)	PX	Common bacterial blight, seed weight, rust, white mold	Jung et al., 1997; Park et al., 2000, 2001
A55×G122 (RI)	AG	Performance in: Andean×Mesoamerican crosses, <i>C</i> , white mold resistance	Johnson, 1997; Miklas et al., 2001a
Benton×NY6020-4 (RI)	B60	White mold	Miklas et al. 2001b
OAC Seaforth×OAC 95-4	S95	Common bacterial blight	Tar'an et al., 2001
Belneb-RR-1×A55 (RI)	BA	Halo blight, common bacterial blight and bean common mosaic virus	Ariyaratne et al., 1999
Bunsi×Newport (RI)	BN	White mold	Kelly and Kolkman, 2001
Montcalm×FR266 (RI)	MF	<i>Fusarium</i> root rot	Schneider et al., 2001
Berna×EMP419 (RI)	BE	Resistance to: <i>Empoasca fabae</i> , <i>E. kraemeri</i>	Murray et al., 2001

RI=Recominant inbred populations; BC=Backcross populations; C = colour gene.

by a combination of traits comprising determinacy, non-twining branches, few vegetative nodes, and long internodes. Less evolved growth habits may show some or only one of these traits. Selection by humans has also led to pods and seeds that are larger ('gigantism') and show different or no anthocyanin pigmentation. The dissemination of cultivated beans from their domestication centres in the tropics to new

areas at higher latitudes led to a selection of genotypes that are insensitive to daylength compared to the wild progenitor, which will only flower under short days. In concert with the changes in growth habit and photoperiod sensitivity, common bean cultivars generally flower earlier than their wild ancestors. The genetic control of this complex array of traits has been super-imposed on a linkage map (Figure 3, Fig-

ure 4). Genetic control of the domestication syndrome involves genes that have a major effect and account for most of the variation observed (>60%). As domestication of the common-bean probably proceeded rapidly, adaptation to rapidly changing environmental conditions must have involved genes with major phenotypic effects (Koinange et al., 1996).

Genome

Among the species recognised as major crops by the USDA, the genome size of beans (450–650 MBp/haploid genome – Bennett and Leitch, 1995) is small and comparable to that of rice (340–560 MBp/haploid genome – Bennett et al., 2000), which is generally considered to be the economically important plant with the smallest genome. Cytogenetically, common bean is a true diploid with 11 chromosomes. There is no evidence for poly-ploidisation. During certain stages of development, polytene chromosomes appear in such readily accessible tissues as the pulvinus. From the limited molecular research that has been published, the gene families tend to be small. The actin gene family has six members, and traditionally large families such as resistance gene analogues (Rivkin et al., 1999) and protein kinases (Vallad et al., 2001) are of moderate size. A large resistance gene-cluster has also been identified (Geffroy et al., 1999). Many genes are well characterised. In particular, a detailed molecular genetic analysis of the important seed coat colour and pattern genes that lead to the nutritionally important isoflavones was recently completed (Bassett et al., 1999a,b, 2000; Bassett and McClean, 2000; Brady et al., 1998). Detailed phylogenetic analyses point to the origin of many of the domestication traits that are important in current agronomic production. These studies provide much of the data necessary for the introgression of traits that may broaden the genetic base of the current breeding pool. It should be emphasized that most of the work on breeding has been performed on a limited set of mapping populations. These are shown in Table 6. Finally, it should be emphasized that *Phaseolus*, in comparison to *Lotus japonicus* and *Medicago truncatula*, is a tropical legume species.

Rhizobium-legume symbioses

Nitrogen is the major limiting nutrient for most crop species. Acquisition and assimilation of N is second in importance only to photosynthesis for plant growth and development. Production of high-quality, protein rich food is thus completely dependant upon the availability of nitrogen. The large rises in cereal grain

yields in developed countries between 1959 and 1990 are directly attributable to a 10-fold increase in N fertiliser application. Concomitant with high rates of application of N fertilisers in developed countries are volatilisation of N oxides (greenhouse gases) into the atmosphere, depletion of non-renewable resources, an imbalance in the global N cycle, and leaching of nitrate to groundwater. By contrast, in developing countries the high cost of N fertiliser, the energy requirements for production, and the suboptimal transportation capabilities limit its use, especially on small farms (Vance, 1997).

One of the driving forces behind agricultural sustainability is effective management of N in the environment. Successful manipulation of N inputs through the use of biologically fixed N results in farming practices that are economically viable and environmentally prudent. Although many diverse associations contribute to symbiotic N fixation, in most agricultural settings the primary source (80%) of biological fixed N is through the soil bacteria *Rhizobium*-legume symbiosis (Vance, 1997). Legumes provide 25–35% of the worldwide protein intake. Important agricultural goals include enhancing the use of and improving the management of biologically fixed N by legumes for both humanitarian and economic reasons (Vance, 1997).

Nitrogen fixing species have played an integral role in cropping systems since the domestication of plants and have prominently featured in rotations and intercropping systems, as alley crops, in pasture systems, as green manures, in agroforestry, and cover crops. More than 50% of the crops grown in Africa, India and Latin America are either intercropped or rotated with N fixing species. Nevertheless, improved strategies must be developed and transmitted to growers to more efficiently exploit biological N fixation (Vance, 1997).

Roots of leguminous plants often associate with bacteria of the family Rhizobiaceae to generate highly specialised structures – nitrogen-fixing nodules. Bacterial cells within the nodule fix the atmospheric nitrogen and produce ammonium that is assimilated by the plant. In return, the plant supplies carbon compounds derived from photosynthesis, for maintenance of the bacteria. Many genes from both organisms are required for the establishment and optimal functioning of this symbiosis.

The original microsymbiont of *Phaseolus vulgaris* is *Rhizobium etli* (Segovia et al., 1993). The genome of this Gram-negative bacterium is distributed among several replicons: one chromosome with the genes for maintenance and growth and from one to

eight large plasmids, ranging from 100 to 700 kbp in size. The genetic information present in these plasmids may constitute up to 50% of the total bacterial genome. The plasmid carrying most of the information that is indispensable to an effective symbiosis is known as the symbiotic plasmid (pSym). *R. etli* strain CFN42 carries six plasmids, the pSym of which is 390 kbp in size (Davila et al., 2000). Complete sequencing of the CFN42 genome as well as analysis of its expression under symbiotic conditions (by transcriptomics and proteomics) has been initiated at the CIFN in Cuernavaca. So far, the complete sequence of the pSymCFN42 has been obtained and annotated (González et al., 2003).

Transformation systems

Transformation of leguminous species, and of large-seeded legumes (grain legumes in particular), is often difficult. Proof of transformation requires that, at least for sexually propagated species, transmission of the introduced DNA be confirmed by molecular analysis of the offspring of primary transformants. In addition, to be of practical value, transformants should correctly express all the introduced genes. A drawback of biolistic gene delivery is the often complex and unpredictable pattern of DNA integration. As a result, there is a growing consensus among breeders that the precision of the *Agrobacterium tumefaciens*-mediated integration mechanism and its tendency to produce low- or single-copy insertions constitutes a considerable advantage over direct gene-transfer techniques.

Stable genetic transformation of beans via particle bombardment has been reported, albeit at very low frequencies. Transgenic navy bean plants (*P. vulgaris* cv. Seafarer) have been obtained following electric-discharge mediated particle acceleration. After bombardment, bean-seedling meristems were subjected to a time-consuming tissue culture protocol involving shoot-induction. Nevertheless, transformed plants were recovered at a very low frequency (0.03%) (Russell et al., 1993). Aragão et al. (1996) reported the regeneration of transgenic beans via particle bombardment using a high-pressure helium device to introduce DNA into embryogenic axes. Shoot formation was induced from bombarded explants, shoots were rooted and stable transgenic plants were generated at an average frequency of 0.9%. Kim and Minamikawa (1996) reported the regeneration of transgenic *P. vulgaris* cv. Goldstar plants via gold particle bombardment of shoot apices of embryogenic tissues. Unfortunately, most shoot apices were chimeric showing both trans-

formed and non-transformed sectors and only 0.5% of the explants produced transgenic seeds. Recently, Aragão et al. (2002) again used bombardment techniques to transform the *P. vulgaris* cultivars Carioca and Olathe with the phosphinothricin acetyl transferase gene (*bar*) that encodes tolerance to the herbicide 'glufosinate'. Only 0.5% of the regenerated plants (T_0) were resistant to the herbicide, and of these plants only two were tolerant in the first, sexual generation (T_1). Nevertheless, these plants were resistant to herbicides in both glass-house and field trials and have been included in a Brazilian breeding programme.

Dillen et al. (1997a) were the first to use *Agrobacterium*-mediated transformation of *Phaseolus*. They transformed *P. acutifolius* A. Gray (tepary beans) and provided evidence for the transmission of the transgenes to the progeny. The procedure included the co-cultivation with *A. tumefaciens* of green nodular callus from bud explants, and the regeneration of shoots in the presence of antibiotics (kanamycin or geneticin). In addition, only one transformed callus-line yielded transgenic plants of clonal origin that were fertile. Nevertheless, it should be possible to introduce *P. vulgaris* genes into *P. acutifolius* using this procedure then cross them back into *P. vulgaris* since the two species are compatible (Dillen et al., 1997a). In the meantime the authors, as well as CIAT (see pp. 88–89) have improved the protocol, so that three different varieties of *P. acutifolius* can now be transformed, and the efficiency is such that between 5–10 transformants can be obtained in one experiment (De Clercq et al., 2002; Zambre et al., 2003). Within the grain legumes, *P. acutifolius* is thus now one of the few species for which the number of transformed plants that can be generated is large enough to enable the application of transgenic techniques. It is possible to introduce *P. vulgaris* genes into *P. acutifolius* using this procedure (Mejía-Jiménez et al., 1994). Of course we realise that the deliberate release of transgenic plants is controversial and for this reason, transformed beans will only be used to answer biological questions in the first instance.

BAC and cDNA libraries

Several BAC libraries exist or are being developed for various genotypes – Sprite (see Vanhouten and MacKenzie, 1999; and p. 111 – UN/L – Sally MacKenzie), *Phaseolus lunatus* cv. Henderson (lima bean), *P. vulgaris* DGD 1962, *P. vulgaris* cv. BAT93, and *P. vulgaris* G02771 (see pp. 104–108. ARS/UC – Paul Gepts). Many cDNA libraries have been or

are being constructed (see Table 9, p. 78). Seeds of the recommended cultivar BAT93 (BAT93 is one parent of the main linkage-mapping population BAT93×Jalo EEP558) are available from P. Miklas [pmiklas@betatricity.wsu.edu or s.beebe@cgiar.org].

Breeding objectives

Plant improvement implies selection among genetically variable individuals or populations to obtain superior expression of a desired trait. Many disciplines have evolved over the past century that contribute to this end: e.g. Mendelian genetics, quantitative genetics, statistics, molecular genetics, pathology, and physiology. In particular, tools derived from biotechnology have led some to refer to 'molecular breeding'. Attempts to classify breeding as traditional, conventional, modern, molecular or participatory lose sight of the fact that these approaches are complementary. The plant breeder is faced with the challenge of drawing upon and coordinating the use of the many tools developed for the common purpose of improving a crop species for the benefit of the farmer. Some of these tools are described below.

Field breeding

Most traits are still selected by conventional means at field sites where the most important diseases, edaphic constraints and drought are found (cf Singh, 1999). Gene-banks of $\cong 25\,000$ and $13\,000$ accessions of common bean that have been the source of disease resistance, abiotic stress tolerance and increased yields are available at CIAT (in Cali, Colombia) and the USDA Western Regional Plant Introduction Station (in Pullman, WA, USA), respectively.

Participatory plant breeding (PPB)

In Africa, but not Latin America, participatory plant breeding of beans has a long history. PPB has important applications in a small farmer crop like beans with well-defined production and market niches, and will serve to deliver the outputs of breeding to end-users more rapidly. Target regions in both the Andean zone and in Central America would be logical areas in which this activity could be developed. Sites and farmers should be identified that are representative of environments and market criteria of a broader sector of the target region.

Marker assisted selection (MAS)

Marker assisted selection has been implemented in various bean-breeding programmes especially for selection of the *bgm-1* gene that codes for resistance to Bean Golden Yellow Mosaic Virus (BGYMV). This programme is based on: (1) the critical importance of BGYMV in tropical America; (2) the fact that this particular gene is the most important and effective gene available; and (3) that while greenhouse inoculation is possible on a limited scale (Morales and Singh, 1991), massive resistance screening is not practical. Once such genes are identified, and reliable PCR-based markers are available for massive screening, they can be manipulated with greater confidence through MAS. Other genes that are foreseen as priorities for selection by MAS include an important QTL for BGYMV resistance, the *bc-3* recessive gene for BCMV resistance, and possibly genes for P use efficiency.

Quantitative trait and other functional analyses

Molecular analysis has proven to be a useful tool even when the genes or QTL identified are not candidates for MAS. QTL analysis has been used as a tool for revealing the inheritance of complex traits such as biological nitrogen fixation (BNF), root structure for nutrient uptake, and drought tolerance. Combined with physiology, QTL analysis can reveal physiological relationships and interactions with greater precision than was possible previously. These methods could be combined with a candidate gene approach to seek underlying mechanisms of P use efficiency. At present primers for a ferritin gene are being employed to seek QTL for higher seed iron content and improved nutritional value. Beans have been transformed with genes aimed at control of BGYMV through biolistics at the University of Wisconsin and subsequently in CENARGEN–Brazil, but unfortunately the genes did not have the expected effect on resistance.

Objectives for specific environments

Mono-cropped beans in favourable environments

Mono-cropping is the favoured system of large, input-rich farmers in Latin America such as those in Argentina and Brazil, but is also practiced by small farmers in the north of Ecuador and medium-sized farmers in the Dominican Republic. Beans in this system are largely commercial crops. Modest to high inputs are used and thus soil fertility is not usually an issue, but farmers seek to protect their investment with disease resistant cultivars. IPM is an important component

since mono-cropping can favour the build-up of pests. As a result, pesticide abuse is common. Soil compaction is a serious problem in Brazil due to excessive tillage.

Associated beans as a crop of primary importance

This system, particularly the maize-bean association, is the most common traditional system in both Latin America and Africa. It is practiced in one or another form in Central America, Southern Brazil, the Andean Zone, and Eastern and Southern Africa, where most bean producers are small, resource poor farmers. In this production context, beans are both a product for home consumption and an important income source. Although the biophysical features of the environment are far from optimal, they are not critically limited by abiotic stresses. Thus the possibility exists of improving productivity through a combination of genetic and resource management solutions that are accessible to farmers who do not have the capital to resolve these problems through inputs. Lack of capital for pesticides and the dangers of pesticide toxicity also make breeding for disease resistance a desirable goal. Similar rationale applies to bean–banana and bean–root crop associations in Africa.

Associated beans as a secondary crop

One of the strengths of beans is their ability to adapt to a variety of niches. Short or medium season bush types that offer minimum competition to the primary crop are used as secondary crops. Inter-cropping with coffee after pruning is an excellent example of this system. Given the favourable environment chosen for the primary crop, abiotic stresses are usually minimal. Disease resistant varieties are desirable but these are usually obtained as spin-offs from the work with other systems.

Mono-cropped or associated beans in fragile niches

In some important agricultural settings, the environment is so harsh that few crops are productive. This is the case of the dry highlands of Mexico and the northeast of Brazil for example. As a result of its adaptable physiology and its indeterminate flowering pattern, beans still produce (albeit 400 kg ha⁻¹ or less) in environments where other crops like maize fail completely. Although stress resistance has modestly increased through breeding, these are problems that are best addressed through crop and resource management. In these environments, breeding will be mostly targeted towards disease resistance.

Table 7. Percentage of total bean production areas potentially affected by P deficiency and Al toxicity in countries and regions of the developing world

Regions or countries	% Total bean area affected by:	
	P-deficiency	Al-toxicity
Brazil	51	61
Mexico	55	2
Central America	62	19
Southern Zone	22	13
Andean Zone	66	26
Eastern Africa	65	52 ^a
Southern Africa	80	42 ^a

^aAcid soils with pH 5.2 and below as well as a higher prevalence of Al toxicity (Wortmann et al., 1998).

Pest resistance

Diseases and insects represent some of the most important risks that farmers confront. All farmers, both large and small, are risk-averse – some more than others. Breeding for disease resistance avoids risk of yield losses, and farmers are very appreciative of resistant varieties to protect their profit margin. Some of the most significant successes in bean breeding have been in the area of disease resistance. At least five major diseases [anthracnose, angular leaf spot, common bacterial blight, BGYMV, and bean common mosaic virus (BCMV)] are widespread, and several others are important locally or regionally. Central America is a case in point. BGYMV is the single most important disease in the region, and varieties resistant to BGYMV are widely grown in several countries. Adoption studies suggest that about 40% of the area in the region is planted to improved varieties. Yet in a 20-year period, region-wide yields have risen by only 100 kg ha⁻¹, from 550 to 650 kg ha⁻¹. If the yield increase could be attributed entirely to the area planted with improved varieties, one would predict yields of 800 kg ha⁻¹ for improved cultivars – still far below the potential of the crop. Thus, breeding for disease resistance has minimised crop losses by maintaining production and yield stability in areas where the crop would otherwise have been abandoned. It has not however increased yield potential dramatically.

Abiotic stresses

Drought stress is another problem that farmers frequently face. Beans require between 200 and 400 mm of rainfall or comparable residual soil moisture during growth and development. It is estimated that up to 73% of the total Latin American and 40% of the total

African bean production occurs under micro-climates that have moderate to severe mean water-deficits at some time during the cropping season. Recent studies suggest that only 7% of the bean-growing area is well watered. Except for a few highland areas with abundant and well-distributed precipitation, and regions where irrigation is available, bean production is exposed to the risk of drought. Soil problems due to toxicities and/or nutritional deficiencies limit productivity. Beans are frequently produced on acid soils that are low in available P and/or high P-fixing capacities. Over 50% of bean-growing areas in Latin America and 65–80% of these areas in Africa are thought to be critically deficient in P. Such soils are often high in Al and beans are affected by Al toxicity. Details of bean growing areas in Latin America affected by P deficiency and Al toxicity are shown in Table 7. A major portion of both Africa and Latin America are also affected by Mn toxicity and low availability of N in soil. Although very little is known of the extent and significance of these micro-nutrient balances in bean production systems, preliminary observations indicate that it is also about the same as for potassium.

Small farmers also do not have the capital to solve edaphic limitations through inputs. Moreover, soil problems differ from disease and drought as constraints in the sense that they are largely invariable. A producer knows what yield to expect under the particular fertility conditions, and can adjust investment of other inputs accordingly. Although the extent that edaphic problems can be resolved through breeding programmes is uncertain, their effect will be mostly on yield.

Yield potential

Globalisation of trade in agricultural products will increase the pressure to improve bean yields. Yet, in a crop as diverse as beans, yield potential must be taken in a very relative sense. We have seen that bean environments vary widely in their productivity. Often the cropping system itself limits the yield potential if for example, only early varieties (hence, lower yielding) are acceptable. A given yield level (e.g., 1000 kg ha⁻¹) may be totally acceptable in high value grain type but not in a lower value grain, or in a production system with high production costs. Thus goals for yield potential must be seen in the context of a given region, production system and grain type. Nevertheless, yields throughout Africa and Latin America are well below the potential of the crop by any standard. Most countries register national averages between 500 and

800 kg ha⁻¹. Improving yields is therefore an imperative. Data on the profitability of beans in Nicaragua and in Colombia (see above) clearly show that improved varieties produce higher yields and result in increased incomes. Several strategies are being pursued to improve yield potential, including the use of wild germ-plasm through the advanced backcross method as well as crosses among gene pools and races. Another promising development is the renewed effort to improve climbers for the very small and land-limited farmer. Interestingly, increased productivity may be emerging in an unexpected way – from work on edaphic resistance. Lines that were selected under moderate aluminum and phosphorus stress also perform well under optimal soil conditions, yielding as much as 40% more than the standard high yielding controls. It is possible that selection has led to improved root systems that perform well under any conditions.

Nutritional quality

More nutritious beans serve both rural and urban consumers independently of how and where they are produced. As noted above, beans are especially rich in iron and protein. When bean consumption patterns are compared to iron deficiencies and the frequencies of anaemia in women (27% of whom exhibit iron deficiencies) within Latin America, it is clear that iron-rich beans could make a particularly important contribution to health in this region. In Sub-Saharan Africa, the situation is even worse, with 40% of women suffering from iron deficiency. Often the bean farmers are women, and even in areas in which male family members cultivate beans commercially, such as Uganda, women tend their own plots of beans for home consumption. Thus, women are in a position to receive and apply technology in the form of new bean varieties. Raising the zinc content is another possibility – nutritional studies have shown that high zinc beans contribute zinc to the human body. In all cases, maintaining a reliable supply is a crucial element in exploiting their nutritional potential and should not be overlooked.

Genomics, transcriptomics and proteomics

Molecular techniques are radically altering the way that plant breeding is being performed. In a sense this is surprising for the individual methods that derive from biochemistry, physiology, genetics, structural

Table 8. Some desired characteristics of 'new beans'

Problem	Target	Genetic component?	See
Anti-nutritional factors	α -Amylase inhibitors, Arcelins, Lectins Phenolics, Tannins, Phytates, Trypsin inhibitors	Often single genes	pp. 61–62
Flatulence	Raffinose, stachyose, verbascose	Genotypic variation	pp. 61–62
Hard-to-cook	Cotyledonary middle lamella	Genotypic variation	pp. 61–62
Low %Ndfa		Genotypic variation	Hardarson et al. (1993)
Low protein seed levels	Phaseolin and APA gene families	Single, complex loci	ARS/UC (pp. 104–108)
Plant type	Determinancy genes	<i>fin</i> locus	ARS/UC (pp. 104–108); Kelly (2000)
Pod shatter	Pod string	<i>st</i> locus	ARS/UC (pp. 104–108)
Poor nodulation	Legume and <i>Rhizobium</i>	Many	pp. 69–70
Sensitivity to <i>Colletotrichum</i>	Several major loci and QTLs for resistance	COK-4 (protein kinase), B4 cluster and others	Melotto and Kelly (2001)
Seeds low in S-amino acids	Phaseolin	Single, complex locus	pp. 61–62
Susceptibility to seed-boring insects	Arcelin-Phytohemagglutinin- α Amylase inhibitor (APA)	Genotypic variation Single, complex locus	ARS/UC (pp. 104–108)
Low yields			Kelly et al. (1998)

biology, and informatics are hardly new. What has changed however is the scale at which genes can be sequenced, their expression analysed, and proteins identified. Genomics, transcriptomics, and proteomics (when applied to beans we call them Phaseomics) permit the study of many (and sometimes all) genes of a particular organism. Significant discoveries concerning the inter-relationships between some of the basic metabolic functions of an organism have been made this way. As a consequence, an integrated, almost holistic view of the organism is evolving. What were once thought to be separate, unrelated functions are now seen as part of a complex network of interacting genes and their products. From an applied perspective, it is possible that studying what seem to be unrelated problems, such as floral biology and disease resistance, may unveil previously unrecognised relationships. For example, in *P. vulgaris* a series of clearly defined genes are necessary to paint the flower a specific colour. Yet flowers are also the point of entry

of the white mould pathogen that causes a disease to which all known bean cultivars are susceptible. It is thus possible that in studying the biology of flower development, 'Phaseomics' would help unravel the mysteries of the white mould and provide avenues to increase resistance to this disease.

Perhaps the most important information necessary to address both fundamental and applied questions in the agricultural and biological sciences is the basic DNA sequence. Although this information is complete for some species (e.g., *Arabidopsis thaliana* and rice), public databases hold relatively few entries for *Phaseolus* (<500 nuclear-encoded genes). There are several ways of obtaining molecular markers and one of the cheaper is to sequence messenger RNA's extracted from tissues of interest (e.g., developing pods). These so-called expressed sequence-tags (ESTs) are short (450–600 bp) sequences that are like milestones on a chromosome (see Figure 5). Breeders can use them to position other genes. Judicious selection of the type

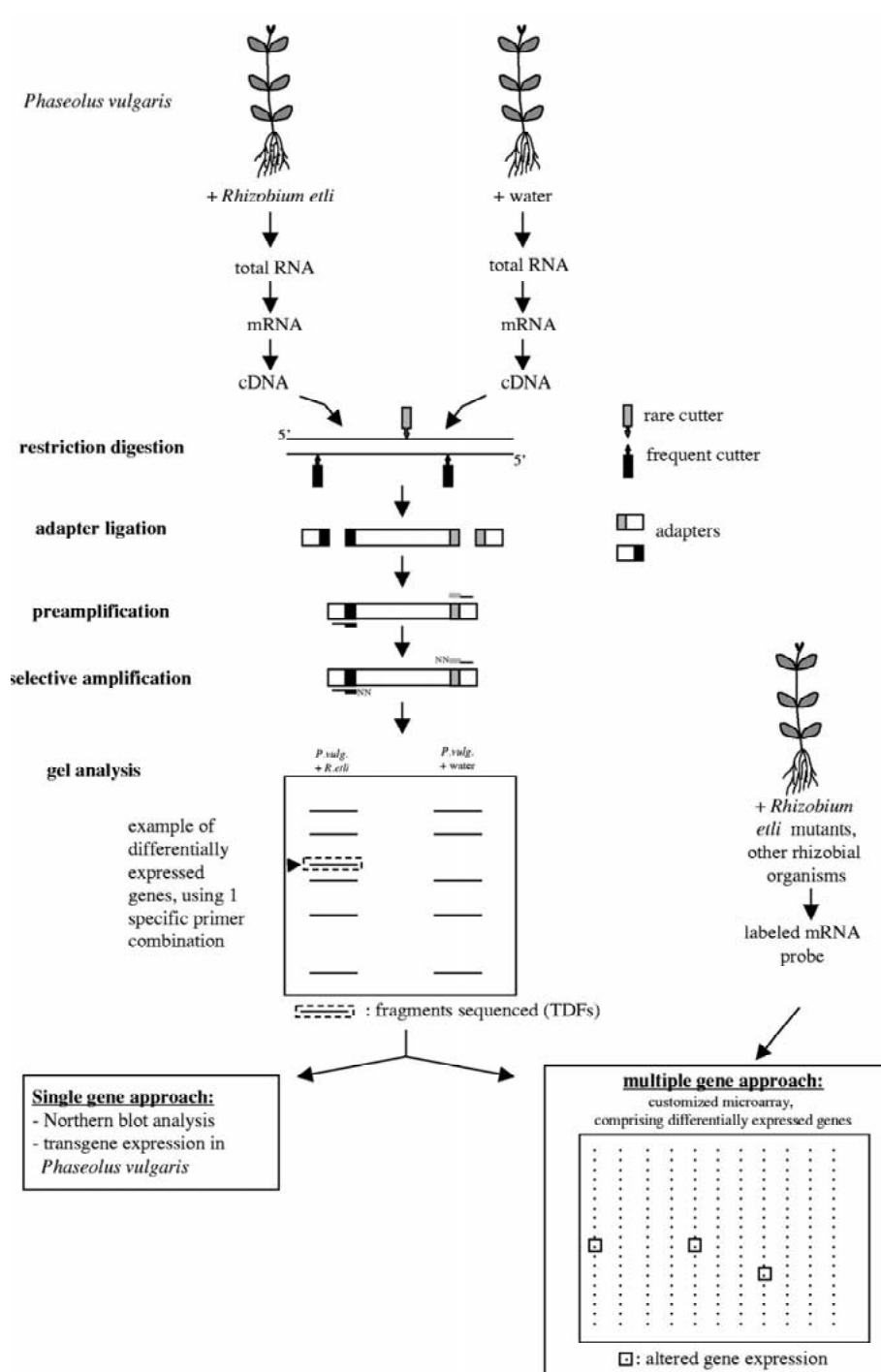

Figure 5. Experimental outline of EST project.

of tissue from which to isolate the mRNA (and hence prepare a cDNA library) provides valuable information not only on the type of genes found in a particular plant, but also on the conditions in which they are expressed. EST projects thus permit 'skimming' of the genome. How much information they gather is dependent on pre-existing information as well as on the abundance of mRNAs, their stability and so on. Nevertheless, they are an efficient way of generating data that can be directly applied in traditional breeding programmes. Another, more thorough technique, is to completely sequence the genome. A large proportion of the funds donated to Phaseomics will be used to pay for the commercial sequencing of BACs and ESTs. BACs will be screened for novel genes, SSRs, etc. and placed on the existing linkage maps. ESTs will be obtained from cDNA libraries made from various tissues (Table 9).

The Phaseomics Consortium

Argentina (UNLP – Mario Aguilar)

Effects of soil stresses on nodulation

Argentina produces about 280 000–300 000 tonnes of common beans per year (about 98% of which are exported) primarily in the Northwest region (NWA) of the country. The recent expansion of bean cultivation occurred in deforested areas where successive cropping leads to decreased nutrient contents of the soil. As a result, bean production is not sustainable and yields are below potential. The availability of nitrogen, either from fertilisers or biological nitrogen fixation, limits productivity. Strains of *R. etli* predominate in both the soil and in nodules of beans growing in the NWA (Aguilar et al., 1998), and these indigenous strains limit the effectiveness of introduced strains. Nevertheless, inoculation with high levels of selected rhizobial strains can increase in yields. Unfortunately, the results are not consistent in successive cropping seasons (Aguilar et al., 2001), and optimisation of inoculation requires detailed knowledge of the interaction between bean varieties and selected rhizobial strains. In Phaseomics, we will identify and characterise symbiotic genes that code for resistance to environmental stresses (Batista et al., 2001), and use this information to breed new bean varieties that yield well under marginal conditions. To do this, cDNA libraries will be constructed (in La Plata) from the tissues shown in Table 9. Several thousand of these clones will be se-

quenced from the 5'-end and annotated. Selected ESTs will be spotted on to micro-arrays. Expression analyses will be used to identify stress-related genes. The roles of individual genes identified in this manner will then be analysed in plants using standard molecular and genetic techniques.

Australia (AgWA – Sonya Broughton, Francis De Lima)

Development of a standard insect screening system for beans

Beans are host to a wide range of insect pests including Aphidae (aphids, e.g. *Aphis fabae*, *Myzus persicae*), Hemiptera (bugs, e.g. *Nezara viridula*), Coleoptera (beetles, e.g. *Acanthoscelides obtectus*, *Apion godmani*, *Zabrotes subfasciatus*), Homoptera (whiteflies, e.g. *Bemisia argentifolii*, *B. tabaci*), Diptera (flies, e.g. *Ophiomyia phaseoli*, *Liriomyza trifoli*), Lepidoptera (moths, e.g. *Helicoverpa zea*, *Helicoverpa armigera*) and Thysanoptera (thrips, e.g. *Franklinella schultzei*, *Thrips tabaci*). Mites also damage beans (e.g. *Aphis fabae*, *Tetranychus urticae*). Insect damage is caused by direct feeding on leaves (aphids, flies, thrips, moths), damage to developing pods (beetles, bugs, moths), damage to the stem (flies) and through the transmission of viruses such as bean golden yellow mosaic virus and bean dwarf mosaic virus (aphids, thrips). Once harvested, beans are also susceptible to damage by seed-feeding beetles, which can begin their infestation before harvest.

Methods used to control insects in beans include the use of pesticides, cultural control and biological control. Pesticides only poorly control aphids, thrips and whiteflies, due to the rapid development of insecticide resistance (De Barro, 1995; Lewis, 1997). Increasingly, varieties of plants resistant to insect attack are being used as a method to reduce losses caused by insect feeding and to reduce the population density of pests developing on crops (Carozzi and Koziel, 1997). Resistant plant varieties can be used as the primary method of insect control, or as a component of an integrated pest management program (Wiseman, 1994). Insect resistant varieties have been developed for corn (Wiseman, 1994; Wiseman et al., 1996), rice and soybean (Carozzi and Koziel, 1997). For common beans, varieties resistant to pre- and postharvest damage by beetles (Beebe et al., 1993; Ishimoto et al., 1999; Kornegay and Cardona, 1991) and varieties showing multiple resistance to insect attack (Bueno et al., 1999) are being selected.

Table 9. Existing/planned cDNA libraries for the production of expressed sequence tags (ESTs) in *P. vulgaris* and related species

Plant variety	Organ	Tissue	Treatment	Rhizobia	Institution	
A774	Roots	Tips	±high AI ⁺⁺⁺		CENA/USP/LICR	
BAT93	Flowers	Whole	±high temp.		MBC/M	
	Flowers	Whole	±pathogen		MBC/M	
	Flowers	Whole	±low PO ₄ ⁼		CIAT	
	Flowers	Whole	±high AI ⁺⁺⁺		PRI/W	
	Fruit	Whole	±pathogen		MBC/M	
	Fruit	Whole	±anthracnose		CINVESTAV	
	Fruit	Whole	±low PO ₄ ⁼		CINVESTAV	
	Leaves	Whole	±pathogen		PRI/W	
	Leaves	Whole	±anthracnose		INRA/CNRS/O	
	Leaves	Whole	±low PO ₄ ⁼		MSU/B	
	Leaves	Pulvinus			LBMPS	
	Nodules	Whole	±high temp.	<i>R. etli</i>	UNLP	
	Nodules	Whole	±drought	<i>R. etli</i>	UNLP	
	Nodules	Whole	±high AI ⁺⁺⁺	<i>R. etli</i>	UNLP	
	Nodules	Whole	±low PO ₄ ⁼	<i>R. tropici</i>	MSU/B	
	Roots	Whole	±drought		CIAT/EMBRAPA	
	Roots	Root-hairs	±inoculation	NGR234	LBMPS	
	Roots	Meristems			LBMPS	
	Roots	Whole	±high AI ⁺⁺⁺		PRI/W	
	Roots	Whole	±low PO ₄ ⁼		MSU/B	
	Seedlings	Roots	±PGPR		UL/RSVS & AgCAN	
	Seedlings	Roots	±low temp.		UL/RSVS & AgCAN	
	Seedlings	Roots	±VAM		UL/RSVS & AgCAN	
	Seeds	Cotyledons			CINVESTAV	
	Seeds	Embryos			CINVESTAV	
	Seeds	Endosperm	High phytate		CENA/USP/LICR	
	Seeds	Endosperm	Low phytate		CENA/USP/LICR	
	Stems	Internodes			LBMPS	
	BAT477	Nodules	Cortex	±low PO ₄ ⁼	<i>R. tropici</i>	INRA/M & CIAT
		Roots	Whole	±inoculation	CNPA512	UL/CPM
Cargamanto	Roots	Tips	±high AI ⁺⁺⁺		CENA/USP/LICR	
Carioca 80SH	Roots	Tips	±high AI ⁺⁺⁺		CENA/USP/LICR	
DOR364	Roots	Adventitious & Basal	±low PO ₄ ⁼		CIAT	
G4000	Roots	Tips	±low PO ₄ ⁼		CENA/USP/LICR	
G12873	Ovules	(Young)			PIN	
	Pods	Teguments			PIN	
	Seeds	(Developing)			PIN	
G-19833	Leaves	Whole	±low PO ₄ ⁼		CIAT	
G-19833	Roots	adventitious & basal	± low PO ₄ ⁼		CIAT	
G-21212	Leaves	Whole	±drought		CIAT	
Jalo EEP558	Leaves	Whole	±anthracnose		INRA/CNRS/O	
Jalo EEP558	Seeds	Whole	Germinating		NDSU/F	
Midas	Ovules	(Young)			PIN	
	Pods	Teguments			PIN	
	Seeds	(Developing)			PIN	
Neg. Jamapa	Nodules	Whole	Inoculation	<i>R. etli</i>	CIFN/UNAM & UM	
	Pods	Whole			CIFN/UNAM & UM	
	Roots	Whole	±low PO ₄ ⁼		CIFN/UNAM & UM	
Negro Jamapa	Roots	Whole	±drought		IBT/UNAM	
Negro Jamapa	Shoots	Whole	±drought		IBT/UNAM	
Sprite	Fruit	Ovules			UN/L	
	Roots				UN/L	

Table 9. Continued.

Plant variety	Organ	Tissue	Treatment	Rhizobia	Person responsible
SEL1306/G2333	Endosperm		±drought		ESALQ/USP
SEL1306/G2333	Roots	Tips	±drought		ESALQ/USP
SEL1308	Seedlings	Shoots	± <i>C. lindemuthianum</i>		ESALQ/USP
Emp419	Leaves	Whole	± <i>Empoasca fabae</i>		PA/UG
OAC95-4	Leaves	Whole	± <i>X. campestris</i>		PA/UG
<i>P. angustissimus</i>	Leaf	Whole	±sub-zero temperatures		CDC/US

Our aim is to develop a standardised system for screening insect resistant and tolerant varieties of beans. This will involve three stages:

1. Review of the literature to determine which insects are present on the common bean and are considered to be the main economic pests. From this review, a list of groups of insects for testing will be developed. A field review will be required to determine the economic injury levels under different climates (e.g. 10 aphids/plant in a dry climate has a greater impact than in a wet climate because of rate of plant growth and compensation for damage).
2. Laboratory screening. A protocol will be developed to determine at what insect pressure beans are able to recover from damage. This involves determining exposure time and will be tested at different stages of the plant lifecycle to obtain a tolerance/resistance rating for specific insects. Based on this information, lines that are resistant to particular insect groups will be determined and fed back to the *Phaseomics* group for further development.
3. Field trials. Resistant and tolerant varieties will be tested in the field under different climates to determine yield and performance. To cover variations in climate and growing conditions, several countries will be selected. Extensive screening of several lines grown in comparison with standard varieties of beans will be used in each country. Scoring for damage and yield will be done in collaboration with local field staff.

Australia (APAF – Gary Cobon)

Proteomic analyses of beans

The Australian proteome analysis facility (APAF) has extensive experience in analysing proteins that are expressed by plant varieties of varying characteristics. Leaf, fruit and roots of wheat, rice, cotton and corn

have been analysed this way, along with bacteria that interact with them (see Nouwends et al., 2000). As a result, greater understanding of the biochemical reasons for higher productivity, temperature and salinity tolerance, disease resistance as well as the reasons for the plants having particular properties (e.g., for dough formation) has been achieved. These results have provided plant breeders with readily applicable markers for use in breeding programmes to select for variants with even more desirable qualities.

Our approach at APAF uses two-dimensional gel electrophoresis to separate proteins in extracts. Despite a great deal of investigation into alternate methodologies, 2-D PAGE still has the highest resolution of any analytical protein separation technology. APAF has the capacity to run more than 200 such gels per week. APAF has also paid particular attention to the study of hydrophobic membrane proteins. Here, the challenge has been to develop means to solubilise these proteins in a form that is compatible with the first dimension separation step. It is not possible to use powerful ionic detergents for this solubilisation as they alter the isoelectric point of the proteins. APAF has developed a range of solutions that can be utilised particularly to dissolve these intractable proteins without interfering with their isoelectric point (pI).

Once solubilised, the proteins are separated by isoelectric focussing on any of a large range of immobilised pH gradient (IPG) strips. APAF has assisted in the development of a range of such strips that cover any of a large selection of pH ranges. Strips are now available that cover from broad ranges (pH 3–10) to ranges as narrow as one pH unit. The advantage of the narrow pH range strips is that each strip can be loaded with a large amount of protein. The lower abundance proteins within that range can be observed.

Separation in the second dimension is based on the size of the proteins. The resulting 2-D polyacrylamide slab can contain up to 3000 different spots,

each of which is a different protein or a variant of the same protein that has been post-translationally modified. Usually triplicate gels are run of the variants of the plant that are to be compared. In instances where the availability of material is not a limitation (which is the case with most plants) the more gels that are run the less likely that investigations will result in the identification of variations that are due to gel-to-gel variations.

Gels are stained with very sensitive fluorescent dyes as the intensity of the fluorescence is proportional to the amount of protein in the gel over at least a two-log range. This enables not only the presence or absence of a particular protein in a gel to be identified but variations of as little as two-fold in the amount of a protein between gels can be determined. Subtle differences in the amounts of particular proteins in plant varieties make the difference: it is less common that a particular protein is absent.

Computer images of the gels are obtained by scanning the fluorescent gels. The replicate computer images are combined using imaging software programs. Comparison of the images allows identification of the proteins that vary in abundance in the extracts. Once identified, the proteins that differ between the extracts are excised and placed into microtitre plates. At APAF, we utilise a robotic spot cutter for this purpose, as it is often necessary to pick several hundred from one gel. The proteins from the extract are then digested with an endoproteinase. Trypsin is commonly utilised as it gives a reasonable number of fragments from most proteins that are within the size range suitable for subsequent analysis by mass spectrometry. The resulting digests are then analysed by mass spectrometry. If the complete gene sequence is of the organism or a close relative is known, MALDI-TOF mass spectrometry works well as the output of this analysis, the mass of the trypsin peptides, is sufficient to give an identification of the protein (particularly when combined with the approximate molecular weight and/or isoelectric point information that can be obtained from the gel). If detailed sequence information is not available, tandem mass spectrometry can be used even though it is slower, more labour intensive and consequently more expensive. The resultant amino acid sequence information that is obtained more than compensates for this added expense as it enables identification of the protein in situations where genome sequence information is less reliable, or it enables the design of oligonucleotide primers for the PCR amplification of cDNA fragments and subsequent identification of the

protein by gene sequencing. Once the individual proteins have been identified, it is possible to identify the biochemical pathways that have been modified in the variants. In many cases, the identification of the variant pathway has come as a complete surprise that could not have been predicted in the absence of the proteomics information.

Here we will analyse bean varieties at the protein level. Our experience suggests that analysis of transcription patterns is in itself not sufficiently accurate to reflect the level of the proteins within a cell at any particular time. To do this, it will be important to have access to genome sequence information for the bioinformatics segment of the programme. Combination of proteomics and transcriptome analysis will give new insights into symbiotic development of legumes.

Australia (UWA/P – Craig Atkins and Penny Smith)

Assimilation of fixed N

Crop legumes fall into two groups on the basis of the pathways used to assimilate fixed N in nodules and the N-solutes that translocate this N to the host plant. Apparently all assimilate ammonia initially as the amide group of glutamine through cytosolic glutamine synthetase (GS) in the infected cells. While most temperate legumes (e.g. peas, lupins, clovers, medics, etc.) translocate this glutamine (or asparagine), in xylem to the host shoot, species of tropical origin form and translocate the ureides, allantoin and allantoic acid. The formation and translocation of fixed N as ureides is restricted, almost exclusively, to species of the tribes *Desmodieae*, *Indigoferae* and *Phaseoleae* (Atkins, 1991) within the Phaseoloid group. This group includes important crops like soybean, cowpea, and mung bean as well as members of the genus *Phaseolus*.

Roots and other tissues of the 'ureide-forming legumes' assimilate soil mineral N (NO_3^- or NH_4^+) into glutamine and asparagine (Atkins and Smith, 2000) and these are the translocated forms of N in both xylem and phloem. Thus, elevated expression of the ureide synthetic pathway is a specific metabolic feature of the symbiosis. In fact, the unique association of ureide synthesis with nodules is sufficiently specific that an assay for xylem-borne N-solutes has been developed as the basis of a practical field method to estimate relative proportions of fixed and soil-N in soybean (see Hardarson et al., this volume).

Ureides are oxidation products of purines (xanthine and hypoxanthine) formed through the *de novo*

purine pathway, initially as the nucleotide inosine monophosphate (IMP). To accommodate this flux of fixed N in nodules, activity of the ten enzymes in the pathway is enhanced considerably (at least 100-fold) compared to other tissues, including active meristems where *de novo* synthesis of purines is essential for DNA replication (Atkins and Smith, 2000). For this reason, nodules have been exploited as the tissue of choice in which to study the enzymology of purine biosynthesis in plants. We have cloned the nine, purine- (*pur*) encoding genes from *Vigna unguiculata* and have initiated studies to characterise their promoter regions with a view to identifying the effectors that lead to enhanced expression.

The localisation of the purine biosynthesis pathway in plants is different to that of all other organisms in that it is organelle-based. All nine *pur* genes carry pre-sequences that in general have features consistent with targeting to plastids. Both plastids and mitochondria of *Vigna* nodules are capable of IMP synthesis from R5P or PRPP and the activities of a number of pathway enzymes have been confirmed in both organelles (Atkins et al., 1997). Furthermore, a single gene in each case encodes eight of the pathway enzymes and we have confirmed that one of these, (AIR synthetase, *pur5*), encodes a protein that is dual targeted (Smith et al., 1998). We expect that each of the products of the *pur* genes will be confirmed as dual targeted and that this feature may be exclusive to nodules. The mechanisms that achieve these outcomes are not yet known.

There is a noteworthy link between N₂ fixation and the assimilation of fixed-N. When purine biosynthesis is blocked by allopurinol (an inhibitor of xanthine dehydrogenase), fixed-N is not assimilated via alternative pathways, such as those that form asparagine (even though asparagine synthetase is expressed in roots). N₂ fixation is inhibited and the nodules begin to senesce after 24 h (Atkins et al., 1988). Similarly, where ureide synthesis is blocked by anti-sense expression of uricase (activity reduced by 80%), the transgenic plants show symptoms of N deficiency.

These results indicate that N₂ fixation is only effective and is only maintained at high rates when the assimilatory pathway for purines is active and accessible to fixed N. Although the nature of the connection is not clear it suggests that understanding regulation of *pur* gene expression could be a route to enhance symbiotic effectiveness.

We will use the molecular tools developed using *V. unguiculata* to study the regulation of purine/ureide

synthesis in nodules and roots of bean. The close association between the rate of nitrogenase activity and purine synthesis that we have found indicates that one factor in enhancing the effectiveness of fixation in *Phaseolus* bean may be the levels of *pur* gene expression and regulation of protein targeting to organelles in infected cells.

Australia (VCP/M – Helen Irving and Marilyn Kelly)

Signal transduction in host plants in response to Nod factors

Our group is interested in signal transduction pathways. Recent work has focused on signalling pathways initiated in beans in response to Nod-factors isolated from *Rhizobia* sp. NGR234. The root hairs of the host plant are particularly responsive to Nod-factors. Critical to optimising this interaction is understanding of the cellular signalling events that occur in this dynamic interaction at both a molecular and biological (*in planta*) level. Chronicling Ca²⁺ changes and their role in the signalling cascade (Gehring et al., 1997) has been energetically followed by several other groups and is beyond the capacity of our current imaging facilities. As a consequence, we have turned to pharmacological and biochemical approaches to investigate the possible signaling events that are activated upstream and downstream of the Nod-factor induced Ca²⁺ changes. We believe that our approach not only complements that of other workers but also falls into a niche where we can make a significant contribution to the understanding of Nod-factor signalling at a functional level. We have developed the biochemical, cell and molecular biological techniques necessary to dissect and functionally characterise the signalling events upstream and downstream of these changes in Ca²⁺ in legume root hairs that occur in response to Nod-factors (Irving et al., 2000; Kelly and Irving, 2001, 2002). We have begun the initial pharmacological and biochemical characterisation of phospholipase C (Irving et al., 2000; Kelly and Irving, 2001) and G-proteins (Kelly and Irving, 2002) that are activated in the legume host in response to Nod factors. We have shown that both heterotrimeric and monomeric G-protein components are activated in root hairs in response to Nod factors. One of the earliest physiological changes in the host plant in response to Nod-factors (or rhizobia) is initiation of root hair deformation, which in turn means that the underlying structure of the cytoskeleton of these hairs is rearranged. In eukaryote systems, including plants,

rearrangement of actin cytoskeleton is modulated by the monomeric G-proteins of the Rho superfamily. Currently we are establishing co-immunoprecipitation protocols and we will use these protocols to identify proteins interacting (possibly via protein complexes) with either G-proteins (heterotrimeric or monomeric) or phospholipase C. A hybrid yeast system approach using G-proteins or phospholipase C as bait will complement the co-immunoprecipitation studies.

Belgium (CMPG/KUL – Ellen Luyten, Carla Snoeck, Jan Michiels, Jos Vanderleyden)

A cascade of signalling events mediates rhizobia-legume interactions. As a result, nodules form on the roots of the host plant. Cortical cells are infected with highly differentiated nitrogen-fixing bacteroids. We have identified secreted bacterial signals that appear to control discrete steps in the developmental programme such as *N*-acyl homoserine lactones (AHL) (Daniels et al., 2002; Rosemeyer et al., 1998) and a Ca^{2+} -binding protein, calymin (Xi et al., 2000). In this project, we will look for plant genes that interact with these bacterial products. In this way, we will define the molecular and cellular responses of common beans to *R. etli* (wild-type, mutants, or secreted signals).

Isolation and characterisation of differentially expressed genes following inoculation with R. etli CNPAF512

Transcript profiling has been used to analyse genome-wide expression in prokaryotes (Dellagi et al., 2000), fungi (van der Biezen et al., 2000), nematodes (Qin et al., 2000) and plants, including potato (Bachem et al., 2000, 2001), almond (Campalans and Pages, 2001), cassava (Suarez et al., 2000), tobacco (Breyne and Zabeau, 2001; Durrant et al., 2000;) and *Ageratum* (Ditt et al., 2001). In addition, cDNA-AFLP technology is robust, gives reproducible results and requires only small amounts of RNA.

In this project, roots of beans will be inoculated with wild-type *R. etli* CNPAF512 for different times (non-inoculated roots will serve as controls). Root and nodule material will be collected and shock-frozen using liquid nitrogen. Total RNA will be isolated from the frozen material using a high-throughput RNA extraction method developed in our laboratory (Eggermont et al., 1996). Poly(A)⁺ RNA isolation and cDNA synthesis will then be performed as described by Bachem et al. (1996, 1998) (Figure 5 and <http://www.dpw.wau.nl/pv/staff/aflp.htm>).

Transcript-derived fragments (TDFs) identified on the cDNA-AFLP profiles will be excised, amplified by PCR and cloned in an appropriate cloning vector prior to DNA sequencing. Both single- and multi-gene approaches will be used to unravel the function of an interesting gene. In the first instance, beans will be inoculated with specific *R. etli* mutants, and the expression of the particular gene analysed using Northern-blotting techniques. In addition, transgenic bean plants that over-express or co-suppress the candidate gene will be used to assess the interaction with *R. etli*. Micro-arrays will be used in the multi-gene approach to analyse expression patterns following inoculation of *P. vulgaris* with different *R. etli* strains (see below).

Micro-array analysis of differently expressed P. vulgaris genes

Customised micro-arrays comprising differentially expressed genes can be used as high throughput tools to study the signal processes in bean roots challenged by different micro-organisms including well-defined *Rhizobium* mutants (Maleck et al., 2000; Schenk et al., 2000). Producing micro-arrays involves six major steps: (1) amplification and concentration of the cDNAs; (2) spotting the cDNAs onto appropriate slides, (3) extracting mRNA from the appropriate tissue; (4) reverse transcribing (to label) the mRNA; (5) hybridisation of the labelled mRNA to the micro-array; and (6) imaging and quantifying the hybridisation signals. Fluorescent probes will be prepared from total RNA isolated from *P. vulgaris* roots that were either not inoculated or inoculated with *R. etli* strains including those mutated in *casA*, *railR* and *cinIR*, as well as following treatment with purified signal molecules such as AHLs and Nod-factors. Preparation of micro-arrays will be performed in collaboration with Dr. Paul Van Hummelen, research manager of the VIB Microarray Facility in Leuven (see www.microarrays/be).

Belgium (IPBO/B – Nancy Terryn and Marc Van Montagu)

Genetic transformation of Phaseolus vulgaris and P. acutifolius

Our goals are the identification and use of novel genes to broaden the genetic base of common beans. This includes the development of a genetic transformation protocol for *Phaseolus*, and the introduction of useful (foreign) genes to address key problems in *Phaseolus* production.

We have developed an improved *P. acutifolius* agrobacterium based transformation protocol (De Clercq et al., 2002; Dillen et al., 1997a; Zambre et al., 2003). With this protocol, *P. acutifolius* can be routinely transformed. As *P. acutifolius* can be hybridised (through embryo-rescue to *P. vulgaris*) this is an indirect way of genetically improving the common bean. Our studies have focused on the seed storage proteins known as arcelins. These are very abundant seed storage proteins found in some wild *P. vulgaris* genotypes. Seeds of *A. thaliana* and *P. acutifolius* plants transformed with *arcelin-5* gene constructs, synthesised arcelin-5 to levels of 15 and 25% of the total protein content, respectively (Goossens et al., 1999a,b). This high expression level of *arcelin5* is being exploited in a project aimed at expressing *arcelin5* genes modified to contain extra methionine codons. Legume seeds are known to be low in sulphur containing amino acids, including methionine (p. 60). High-level accumulation of these modified arcelin5 proteins should result in increased seed methionine levels and thus improved nutritional balance. As the crystal structure of Arcelin5 has been determined, the influence of substitutions and insertions of methionine codons on protein stability can be evaluated through computer simulations. Six modified *arcelin5* genes, each containing three to five extra methionine codons, were constructed and four of these were found to yield stable proteins in *Arabidopsis* accumulating to levels similar to those of unmodified Arcelin5. One of the constructs (with four methionine residues) was introduced into *P. acutifolius*. Ten independent lines were generated, all of which show stable protein accumulation to levels similar to the unmodified Arcelin5 (De Clercq et al., 2002). To enhance the methionine content of *Phaseolus* beans to that of the FAO reference protein, an *Arcelin5* gene with at least ten additional methionine codons, expressed at the same level as the unmodified protein, is required. Therefore, various combinations have been made of the modifications that yield stable proteins in *Arabidopsis*. These new constructs are currently being tested in *Arabidopsis* and *P. acutifolius*.

We are also continuing to improve the regeneration and transformation protocols for *Phaseolus*, and particularly *P. vulgaris*. *P. vulgaris* can be regenerated using a callus-based protocol (Zambre et al., 1998) which we hope will yield stable transformants. To this end we are looking at factors that influence transformation efficiency (Dillen et al., 1997b; Zambre et al.,

2003) and we have developed a protocol to regenerate shoots from *P. polyanthus* (Zambre et al., 2001).

Belgium (LTCHH/G – Jean-Pierre Baudoin and Alain Maquet)

Inter-specific hybridisation among Phaseolus species (see p. 66)

The Laboratory of Tropical Crop Husbandry and Horticulture at Gembloux Agricultural University investigates the following:

- The genetics of domestication and evolution of beans (molecular systematics).
- The effects of *in situ* wild *Phaseolus* populations on the genetic structure at both inter- and intra-population levels. Special attention will be given to the influence of gene-flow and breeding systems.
- The mechanisms of genetic incompatibility. Comparison of the mapping order of molecular markers will indicate if rearrangements of chromosomes have occurred during development of the different *Phaseolus* species.
- The biochemistry of embryogenesis and the mechanisms of abortion. In particular, histology of interspecific embryos and search of candidate genes in embryo development (probing with genes of model species) will help overcome incompatibility barriers and refine methods of introgression.

Belgium (LoGT/UL – Guido Volckaert)

The contribution of the Laboratory of Gene Technology (LoGT) of the Katholieke Universiteit Leuven to *Phaseomics* is in genome sequencing. LoGT will provide a niche for efficient and cost-effective sequencing of selected BACs (or clones of similar large-sized genomic segments) and will operate in partnership with other laboratories of the consortium. So far, genome sequencing has been based either on full-genome shotgun cloning libraries, or on physical maps of cosmid/phage/BAC clones arranged in a minimal tiling path. The former approach requires large-scale funding *ab initio* (at least \$US 50 million) and substantial computing power for assembly; the latter approach involves a time-consuming and costly mapping phase.

With the current approaches in transcriptomics and proteomics, it is clear that much information from functionally interesting regions of *Phaseolus* can be rapidly gathered. Using the available BAC libraries, the genomic equivalent regions are readily obtained. Sequencing such BACs will yield a genomic frame-

work of target sites that can be expanded to fill-in the gaps between targets systematically, and eventually lead to the complete genome sequence.

LoGT has participated in many of the major genome sequencing projects of the past decade: *Saccharomyces cerevisiae*, *Arabidopsis thaliana*, *Schizosaccharomyces pombe*, etc. (see, e.g., Arabidopsis Genome Initiative, 2000; Winzeler et al., 1999). In addition to contributing sequences to these projects, we have specialised in problem-solving approaches and quality-control procedures (Voet et al., 1997). This includes error checking and solving conflict-positions directly from genomic templates; solving complex and imperfect repeat structures and regions of low A+T content or containing homopolymeric tracts; sequencing unclonable regions; reading through polymerase-pausing and other (e.g., secondary structure) stops. This expertise results in a gapless sequence that is essential for diversity analyses, and a prerequisite in *Phaseolus* genomic sequencing.

The BAC sequencing process (around 100 kb/BAC) can be divided into two phases: (1) the 'routine phase': an initial collection of sequence reads made by systematically sequencing shotgun clones; (2) the 'finishing phase'. Here the 'reads' are assembled into contigs and finalised by closing any remaining gaps (using primer-walking) and making the entire sequence double-stranded. The routine phase can be subcontracted to so-called 'sequencing companies' with proven record of high-quality, large-scale sequencing, as this routine phase is more cost-effective in a specialised facility with automated processing rather than in a purely academic environment. The finishing phase, however, requires more personal involvement, including specialised manual operations that can be more efficiently performed in research laboratories. Thus, competitive offers for 800 reads per BAC to be provided on CD-ROM will be requested from sequencing companies and finishing will be done at the LoGT, including basic bioinformatic analysis. Members of the Phaseomics network at their discretion may provide BACs, or BACs will be selected from libraries based on EST data.

*Brazil (CENA/USP – S.-M. Tsai and D.H. Moon;
LICR – A. Vettore and A.G. Simpson)*

Brazil has approximately five million ha of land planted with *P. vulgaris* varieties and produces three million Mt of beans (see p. 58). Economically, beans are an important cash crop for the many Brazilian

farmers whose properties are small (less than 10 ha) and located in areas of sub-optimal soil conditions (mainly low pH and phosphorus availability and phytotoxic levels of aluminium). It is estimated that only 4% of the planted areas are occupied by large-scale irrigated farms and produce only 15% of the annual production.

In many parts of the world, including Brazil, beans provide the primary source of dietary proteins and carbohydrates as well as other minerals such as Fe (Lott et al., 2000; Sandberg et al., 1993; Sathe et al., 1984). The main storage protein is phaseolin and like all other seed proteins of legume family is deficient in sulphur-containing amino acids, principally methionine. This deficit is made up by including cereal seed storage proteins in the diet, which are themselves deficient in lysine.

In Phaseomics, we will use strictly Brazilian varieties or varieties that are currently accepted for planting in Brazil because of their better performance in this country. We will construct cDNA libraries from the roots and endosperm of various bean varieties, stressed and un-stressed (see Table 8), to allow the sequencing of at least 50 000 Expressed Sequence Tags (ESTs). Libraries will be constructed at CENA/USP and the sequences made publicly available, after proper evaluation, through public databases such as the NCBI Genebank and BeanGenes.

Phytic acid and aluminium tolerance

After the isolation of the poly-A mRNA fraction using commercially available kits, we will use the OR-ESTES system (Neto et al., 1997) for the construction of the cDNA libraries for two main reasons: the first is the reduced quantity of poly-A mRNA necessary to synthesise the cDNA and secondly this methodology greatly compensates for the unequal message abundance that avoids the need to construct complex normalised libraries. To study the production of phytate in beans the material used will be endosperm for varieties with high and low phytate content at various developmental stages and under various nutritional conditions and following the developmental stages indicated by Walker (1973) The candidate varieties are Rio Tibagi, Carioca 80SH, G19833, G21212, G4000, BAT 477 and A774. To study aluminium tolerance, root-tip material from sensitive and tolerant varieties, under stressed and un-stressed conditions, will be used to isolate mRNA (Carioca 80SH and Cargamanto varieties). To generate 50 000 clones we need a total of approximately 100 ng of poly-A mRNA from

each tissue type to generate 10 000 ESTs (4ng/cDNA synthesis and each synthesis generates 20 AP-PCR reactions and each mini-library generates on average 25 clones or approximately 500 clones for each 4ng of mRNA, data from Neto et al. (1997).

Brazil (ESALQ/USP – Maeli Melotto, Luis E.A. Camargo)

Bean EST project – BEST

Expression libraries are needed to accelerate bean genomics. The information provided by the BEST (Bean EST) Project can be exploited in many different ways. We will construct more cDNA libraries, sequence 10 000 expressed sequence tags (ESTs) and build an annotated database for the sequences.

A cDNA library has been constructed from total mRNA extracted from above ground vegetative parts of adult plants of the Andean common bean variety G19833. The source genotype, G19833, is tolerant to low phosphorus levels in soils, is resistant to anthracnose, angular leafspot as well as *Ascochyta* but is susceptible to bean golden yellow mosaic virus and bean common mosaic virus. G19833 is also one parent of the principal mapping population used at CIAT which consists of 87 recombinant inbred lines (F-11 generation) from the cross DOR364×G19833. QTLs for low phosphorus tolerance and disease resistance have been mapped in this population. At a later date, cDNA clones from leaf tissue of the bean line SEL1308 stressed with *Colletotrichum lindemuthianum* (the causal agent of anthracnose) will also be included in the analysis. This is a black bean line derived from the landrace G2333 (Colorado de Teopisca) and possesses the *Co-4* gene for anthracnose resistance.

Two cDNA libraries will be constructed from seedlings non-inoculated and inoculated with the fungal pathogen *Colletotrichum lindemuthianum* that causes anthracnose in common bean. The black bean genotype, SEL1308 was chosen in this study as it carries the *Co-4²* gene for anthracnose resistance (Melotto and Kelly, 2001; Young et al., 1998). Black beans have been described as the best to study nodulation and bean/*Rhizobium* interactions. These libraries will be normalised and directionally cloned into plasmid vectors for 5'-end sequencing. Approximately 10 000 randomly selected cDNAs will be partially sequenced. Libraries will be stored at the Department of Plant Pathology, ESALQ, University of São Paulo, Brazil. All sequences will be analysed for possible function by similarity to known genes represented in public

databases and subjected to motif analysis using a variety of computational tools. Sequence annotation will also include clustering analysis. Finally, clones, sequences and derived information will be deposited in publicly accessible databases and individual clones will be available to researchers upon request.

Later, we will focus on studying disease resistance genes (see Table 9). cDNA clones showing homology to resistance genes will be mapped and those that co-segregate with known genes will be selected for genetic complementation experiments. This work will be developed in collaboration with CIAT (see COLOMBIA (CIAT – Steve Beebe, Matthew Blair, Joe Tohme, pp. 88–89), with the additional aim of developing new micro-satellites from the EST sequences. Ultimately, many of these ESTs will be genetically mapped using RFLP or SNP (single nucleotide polymorphism) based assays, especially as bean micro-arrays become available.

Brazil (LCV/UFPE – Andrea Pedrosa, Marcelo Guerra)

Cytogenetic-based physical map of P. vulgaris

Cytogenetic analysis in beans has long been hampered by the small size and similar morphology of its 22 chromosomes. Although some progress has been achieved by using giant, polytene chromosomes of the embryo suspensor (Schweizer and Ambros, 1979), identification of these chromosomes remained controversial. Recently, most of the common bean mitotic metaphase chromosomes could be identified by a combination of chromosome morphology, heterochromatin distribution and fluorescent *in situ* hybridisation (FISH) with rDNA probes (Moscone et al., 1999).

Our group is interested in establishing a cytogenetic-based physical map of common bean. As a first step, we have integrated the genetic map and the chromosomal map of the species. For this purpose, a new strategy was used in which clustered or linked RFLP clones were combined and directly used as probes for FISH experiments (Pedrosa et al., 2001). This allowed the assignment of all linkage groups of the University of Florida map (Vallejos et al., 1992), and indirectly of the core map (Freyre et al., 1998), to the chromosomes of the species (Pedrosa et al., 2002b). Furthermore, cytogenetic markers for identifying each bean chromosome are now available. No correlation between linkage group sizes and chromosome sizes was observed, suggesting a high variability in Mbp/cM ratios along different linkage groups and emphasising the

importance of a detailed correlation of genetic and physical distances throughout the bean genome.

As a result, our present aim is to:

- Improve the correlation of genetic and chromosomal maps by hybridising BAC clones selected with genetically mapped-markers distributed throughout the genome to pachytene chromosomes of common bean. As demonstrated for other model legumes, this approach allows comparison of both maps in multiple regions (Pedrosa et al., 2002a) and generates a high-resolution physical map (Kulikova et al., 2001). The use of pachytene chromosomes will also allow the assignment of BACs to the eu- or hetero-chromatin domains.
- Expand the maps by integrating groups of unlinked markers through BAC FISH.
- Assist the development of a contig physical map, by supplying anchoring clones, joining non-overlapping contigs and characterising the gaps.

Development of this physical map will not only contribute to the understanding of the common bean genome, but also provide additional markers for future comparative cytogenetic analysis within the genus *Phaseolus*.

Canada (UL/RSVS and AgCAN – Hani Antoun, Serge Laberge)

Novel genes induced by PGPR, mycorrhizae and cold stress

Plant growth promoting rhizobacteria (PGPR) are a very small portion (2–5%) of rhizosphere inhabiting bacteria that are able to promote plant growth or health when reintroduced in large numbers by inoculation (Antoun and Kloepper, 2001). PGPR use one or more of several mechanisms to promote plant growth. Some examples are the production of phytohormones or the improvement of plant nutrition through biological nitrogen fixation. Indirect mechanisms of action are by far the most important and they include biological control of plant pathogens and induced systemic resistance.

Induced resistance is defined as an enhancement of the plant's defence capacity, against a broad spectrum of pathogens and pests (see Ramamoorthy et al., 2001). The resulting elevated resistance due to an inducing agent upon infection by a pathogen is called induced systemic resistance (ISR) or systemic acquired resistance (SAR). Induction of systemic resistance by rhizobacteria is referred as ISR, whereas that by other agents (pathogens or chemicals) is called

SAR. SAR is expressed to a maximum level when the inducing organism causes necrosis whereas PGPR typically do not cause necrotic symptoms. Both SAR and ISR involve the activation of latent resistant mechanisms that are expressed after challenge inoculation by a pathogen.

Some PGPR strains affect the growth of beans (Peix et al., 2001). Petersen et al. (1996) showed that co-inoculation of beans with *Bacillus polymyxa* and *Rhizobium etli* increased lateral root formation and nodule number. These effects were not linked to the ability of the *Bacillus* isolates to produce indole acetic acid *in vitro* (Srinivasan et al., 1996). Inoculation of bean seeds with the PGPR strain *Pseudomonas fluorescens* S97 suppressed attack by the leaf pathogen *Pseudomonas syringae* pv. *phaseolicola* (Alstrom, 1995). Growth and yield of water stressed bean plants were improved by inoculation with the vesicular arbuscular mycorrhizal fungus *Glomus intraradices* (El-Tohamy et al., 1999). Inoculation of beans with *Glomus mossae* also significantly reduced root infection with *Fusarium solani* (Dar et al., 1997).

Here we will characterise and clone novel bean genes (using cDNA techniques) that are expressed during the interaction with:

- PGPR, including non-homologous rhizobia: *Phaseolus vulgaris* appears to be a non-selective host for nodulation because it is able to perceive signals for nodulation from many rhizobia (Michiels et al., 1998). Although most of these interactions produced ineffective nodules, we have previously observed that inoculation of *Medicago sativa* with some combination of homologous and non-homologous rhizobia produced a significant synergistic effect on yield (Antoun et al., 1979). Many rhizobia also act as PGPR with non-legumes (Antoun et al., 1998).
- Vesicular arbuscular mycorrhizae.
- Low temperatures. This part of the work will also indicate if there is a connection between responses to biotic and abiotic factors as observed in *Arabidopsis thaliana* (Timmusk and Wagner, 1999).
- Gene expression will be studied in relation to bean cultivars, plant age, co-inoculation with more than one organism as well as the involvement of biotic and abiotic stresses (see Table 9).

Canada (CDC/USS – K. Bett, B. Tar'an, A. Vandenberg and P. Balasubramanian)

Two of the major constraints to producing beans on the Canadian prairies are the short growing season (~100 days) and low temperatures, particularly during the early part of the season. Improved yield and stability depends on breeding for early maturity, and for resistance to abiotic stresses, particularly low temperatures. With the development of early maturing cultivars, quality has also become a main focus of the bean-breeding programme at the CDC. A combination of field- and marker-assisted selection is being used in the bean-breeding programme, and a genomics laboratory has recently been set up. Germplasm from our frost tolerance and maturity projects will be of interest in other regions on the fringe of the bean growing regions of the world (e.g. higher altitudes).

Frost tolerance

We have identified two species (*Phaseolus filiformis* and *P. angustissimus*) that are able to survive subzero temperatures at the seedling stage. Inter-specific crosses with *P. vulgaris* were made and the ability to withstand the subzero temperatures was transmitted to the hybrids. Next, we will generate cold stress related expressed sequence tags (ESTs), and use the sequence information to develop a set of SSR and SNP markers to create a genetic map of bean based on these and other markers.

Generation and analysis of ESTs To identify the expressed genes involved in freezing stress tolerance, two sets of cDNA libraries are being developed: one from beans grown under normal conditions, and another from plants subjected to subzero temperatures (−4°C). To normalise the libraries from the frost damaged leaves, the clones will be screened at high stringency (to eliminate high abundance clones) with poly (dA/dT)-cDNAs (Wang et al., 2000) prepared from undamaged leaves of the same genotypes that were used to prepare the stressed libraries. Those cDNA clones that do not hybridise strongly will be selected for sequencing on the assumption that they represent transcripts that are unique to the damaged state. Approximately 2000 clones from healthy leaf libraries and 2000 of the challenged-state libraries will be sequenced from the 5' end. ESTs identified this way will be deposited in public data bases such as dBEST and in Beangenes in collaboration with the curator

of the site (see USA (NDSU/F – Phil McClean, pp. 109–110).

Development of SSR and SNP markers for P. vulgaris Data generated from sequencing ESTs will permit rapid development of simple sequence repeat markers (SSRs). We are planning on collecting the sequences generated from the EST determinations in a local database in Genbank format. The local database will then be scanned with a version of BLAST to identify di-, tri- and tetra- nucleotide repeats. PCR primers will be designed for unique flanking sequences of the repeats and tested for polymorphisms across several bean genotypes.

Single-nucleotide polymorphisms (SNPs) are the most abundant form of sequence variation among individuals (Cooper et al., 1990). The proposed work will be focused on determining SNPs from the ESTs. Taillon-Miller et al. (1999) showed, that by comparing the sequence from an individual with the sequence of the pooled genomic DNA, they were able to efficiently identify SNPs without sequencing multiple individual genotypes. For this part of the work, DNA will be amplified from genomic DNA of one of the parents of the mapping population and a mixture of at least ten genotypes including genotypes extensively used in bean breeding in Canada. SNPs and SSRs will add to the currently available markers permitting better genome coverage for MAS and genome mapping.

Development of Phaseolus genetic maps At least 500 ESTs identified in this project will be mapped in a RI population specifically developed for segregation for early maturity and in a RI population derived from the BAT93×JaloEEP558 cross (Nodari et al., 1993) obtained from the UC-Davis group (pp. 104–108). We anticipate that by using genes and ESTs instead of 'anonymous' sequences as genetic markers we will more easily identify putative genes associated with early maturity. Mapping will also be carried out in *P. filiformis* and *P. angustissimus* to enable identification of the introgressed segments in the inter-specific hybrids. Furthermore, the gene map will be used to examine micro-synteny of *Phaseolus* in comparison with other species, thus providing information on genome-wide organisation of genes and evolution of bean genomes. Syntenic relationships will be determined by comparing gene order on the bean map to the order of homologous sequences in other species identified in BLAST searches.

Maturity

Several different mechanisms can be exploited to develop beans that mature early enough to avoid fall frosts. Since early maturity is often associated with lower yields, we are examining strategies to lengthen the growing season such as the ability to germinate in cool soils. Several lines with improved ability to germinate in low temperature soils have been identified. Segregating populations were developed from crosses of multiple parents. These populations are being used to identify regions of the genome associated with this trait using both mapped markers (RFLP/bng clones and SSRs) and random/unmapped markers. The results will allow us to immediately implement MAS in the breeding programme to introgress this trait. Markers and mapping carried out in the frost resistance project will also be used in this project.

Canada (PA/UG – K. Peter Pauls, Art. Schaafsma, Tom E. Michaels)

Our group is involved in development of molecular markers in *P. vulgaris* for the breeding of improved resistance to: (a) common bacterial blight; and (b) the leaf-hoppers, *Empoasca fabae* and *E. kraemeri*. Due to large environmental components, both these traits are difficult to select in a plant-breeding programme. For this reason, we are interested in developing molecular markers from expressed sequence tags (ESTs) of cDNA libraries based on resistant and susceptible lines.

Common bacterial blight (CBB; caused by *Xanthomonas axonopodis* pv. *Phaseoli*=syn. *X. campestris* pv. *Phaseoli*) is one of the most important bean diseases around the world. Our group has been involved in the development of bean lines with improved resistance to CBB. Loci conditioning the resistance to CBB were first introduced to *P. vulgaris* by an inter-specific cross with *P. acutifolius* (Scott and Michaels, 1992). We have identified several markers linked to the quantitative trait loci for CBB resistance and other agronomic traits (Tar'an et al., 2001, 2002).

The potato leaf-hopper (*Empoasca fabae*) is a serious insect pest of field beans in North America where it is responsible for heavy yield losses if left uncontrolled. A closely related leaf-hopper species, *E. kraemeri*, is considered the most important pest of beans in Latin America. Plant resistance offers an attractive alternative to chemical control with respect to management, input and environmental costs. We have shown that *E. kraemeri*-resistant lines developed

by long-term recurrent selection at CIAT in Colombia also harbour resistance to *E. fabae* (Schaafsma et al., 1998). A line resistant to both species of leaf-hopper that is suited to temperate climates has been used in a cross with a susceptible cultivar to create a population of recombinant inbred lines. These have been scored for resistance to both species of leaf-hoppers. Several morphological (Murray et al., 2001) as well as molecular markers have been linked to leaf-hopper resistance loci.

The objectives of the proposed work are:

1. to identify ESTs by sequencing cDNAs of libraries prepared from healthy leaves, leaves infected with *X. campestris* and *E. fabae*-damaged leaves;
2. to sequence existing and novel *P. vulgaris* genomic clones;
3. to use the sequence information to develop a set of robust STS-based markers such as SSRs, CAPS or SNPs for *P. vulgaris*;
4. to develop non-electrophoretic, (micro-array) methods for scoring markers in *P. vulgaris*.

Realising these objectives will lead to the development of better markers for leaf-hopper and CBB resistance loci, significantly contribute to the *Phaseolus* sequence database, and will generate a map of robust molecular markers based on expressed sequences that will be useful to the entire bean research community.

Colombia (CIAT – Steve Beebe, Matthew Blair, Joe Tohme)

CIAT has a strong record in developing common bean varieties for tropical production zones in Africa and Latin America. The target group for bean improvement has been small resource-poor farmers with the goal of contributing to food security, alleviation of poverty as well as ensuring sustainable livelihoods. Since the beginning of the CIAT bean programme in 1973, over 362 CIAT or CIAT-derived varieties have been released in more than 39 countries (estimated value to farmers' in the region – \$US 1200 million). Plant breeding at CIAT uses a combination of field selection and phenotyping coupled with the biotechnology tools listed below. Field breeding is conducted at sites in different ecological zones of Colombia, Kenya, Uganda and Malawi as well as in collaboration with national programmes in many additional countries through the bean networks of Central America (Profrjol), South America (Profriza) and Africa (PABRA; ECABREN and SABREN). CIAT has a mandate to conserve over 30 000 accessions of domesticated and

wild common bean lines as well as related species from all major growing regions. Seeds from these lines are held in trust under the auspices of the Food and Agriculture Organisation of the United Nations (FAO) designated world collection. This gene bank is used as the source of novel traits for breeding improved genotypes.

Research focus

CIAT works on many aspects of breeding, genetics, pathology, nutrition and physiology, the focus has been on breeding beans for biotic stress resistance, especially for disease and insect pests of the lowland and highland tropics. New emphasis is being placed on breeding varieties for higher nutrition that are adapted to abiotic stresses. Beans are frequently produced on acid soils that are low in available phosphorous and high in aluminum. Symbiotic nitrogen fixation is affected by phosphorous availability. In some areas beans are grown on alkaline soils where iron availability is low. Meanwhile, many soils are deficient in nitrogen, potassium and zinc or have high levels of manganese. All these soil conditions affect the nutritional status of the plant, which in turn affects accumulation of nutrients in the grain and total yield. There is thus a direct link between crop nutrition and human nutrition.

Bean biotechnology at CIAT

1. Marker development: One priority of CIAT's biotechnology efforts for common bean has been the development of PCR-based markers. Two main marker types have been emphasized: sequence characterised amplified region (SCAR) markers and micro-satellites or simple sequence repeats (SSRs). These markers have been essential for mapping and tagging genes of agronomic importance and for their eventual selection in marker-based breeding schemes. Other marker systems, such as AFLPs and RAPDs have been used to study the diversity within different species of the genus *Phaseolus* and the many accessions that are stored in the germ-plasm bank.
2. Genetic mapping: All new markers are mapped onto CIAT's principal mapping population as mentioned earlier, which now contains over 500 markers including AFLPs, micro-satellites, RAPDs and RFLPs. Probes from both the University of California at Davis (see ARS/UC) and the University of Florida have been used in this mapping population to correlate the CIAT genetic map with existing integrated maps for the species. A set of micro-satellites is being put together to efficiently map other populations (see below). Several other mapping populations have been developed at CIAT and are used to tag quantitative trait loci (QTL) for characteristics of interest to CIAT plant breeders. These include abiotic stress tolerance (low phosphorous, aluminum toxicity and drought tolerance), micronutrient content (iron and zinc), as well as insect and disease resistance. Several of these CIAT populations are being analysed by other groups involved in studying the molecular genetics of common beans in Brazil, Belgium, France, Germany, Mexico and the United States.
3. Genomic libraries: As part of the process to develop additional micro-satellite and SCAR markers, the biotechnology unit at CIAT has made several types of genomic libraries including one enriched in micro-satellites.
4. cDNA libraries and EST sequencing: Three cDNA libraries have been made from bean tissues at CIAT. The first was a leaf cDNA library constructed from total mRNA extracted from leaves of adult plants of the Andean variety G19833 (see Table 8). This library was made in the pCMV Sport 6.0 vector. A total of 64 000 clones have been plated and picked into 384-well plates that were arrayed onto high-density filters and stored as glycerol stocks. The clones have an average insert size of 1.3 kb. The source genotype, G19833 is tolerant to low phosphorous levels in soils and has multiple disease resistance including anthracnose, angular leaf spot as well as *Ascochyta* leaf blight. G19833 is also one parent of the principal mapping population used at CIAT which consists in 87 recombinant inbred lines (F-11 generation) from the cross DOR364×G19833. DOR364 is a popular Central American variety that is high yielding and adapted to conditions in the region. QTLs for low phosphorous tolerance, agronomic performance and disease resistance have been mapped in this population. Two root cDNA libraries have also been made from mRNA extracted from adventitious and basal roots grown under phosphorous deficiency stress for the genotypes G19833 and DOR364. Both libraries were made in a high efficiency phagemid vector from Stratagene Cloning Systems (Uni-Zap XR). An additional 32 000 clones will be picked from each of the root libraries. About 4000 clones have been sequenced so far and the ESTs are being used to develop molecular

markers. Many of the bean ESTs have homologues in the soybean database.

5. Resistance gene analogues: Analogues to resistance genes have been analysed using degenerate primers to amplify their NBS-LRR, TIR and P-loop regions. Amplification products have been cloned, sequenced and used as probes to map the homologous loci in the bean genome and to identify BACs containing the sequences. The information gained will be used to develop markers for the selection of the resistance genes that co-segregate with the cloned fragments.
6. Transformation and tissue culture: Biolistic and *Agrobacterium tumefaciens*-mediated transformation strategies are being tested for transformation. Inter-specific hybrids with tepary bean have been developed at CIAT through congruity backcross and embryo rescue methods. These have proven useful since they are more amenable than common bean to transformation. Greenhouse testing of beans transformed with GUS has been undertaken and field-testing will be performed once permission of the Colombian bio-safety authorities has been granted.
7. Bio-informatics and databases: CIAT is part of a consortium of CGIAR centres that are developing bio-informatics tools for linking mapping, QTL analysis and germplasm evaluation. Emphasis will be placed on creating databases for managing genotype and genetic mapping information as well as establishing sequence storage and processing capacities. Molecular marker data is continually updated in the BeanGenes AceDB database.
8. Future plans: CIAT has established a DNA microarray facility that will be used to develop new genetic marker systems based on the diversity array system that was developed at CAMBIA. DNA chips to follow gene expression will be developed with clones from the cDNA libraries described above. In addition, single nucleotide polymorphism markers will be constructed using sequence data generated from projects described above.

Czech Republic (IPMB/CB – Jiri Macas, Vit Našinec)

Analysis of repetitive sequences

The laboratory's long-term interest is focused on the molecular structure and evolution of legume genomes. In collaboration with several other groups, the laboratory has been developing new techniques for physical genome mapping using micro-isolated or flow-sorted

chromosomes and *in situ* hybridisation. This work led to the localisation of seed storage protein genes on *Vicia faba* chromosomes (Macas et al., 1993a,b), to the development of methods for fluorescent labelling of specific sequences on chromosomes in suspension (Macas et al., 1995; Pich et al., 1995), and to the construction of the first complete set of chromosome-specific DNA libraries in plants (Macas et al., 1996). Recently, most of the research has been focused on repeated DNA sequences, especially in species possessing large genomes (*Vicia* spp. and *Pisum sativum*) (Macas et al., 2000; Neumann et al., 2001; Nouzová et al., 1999, 2001). In order to isolate DNA repeats from complex genomes efficiently, several novel methods were introduced or adapted, including DNA microarrays (Nouzová et al., 2001), and genomic self-priming PCR (Macas et al., 2000). A database of plant satellite repeats has been established (Macas et al., 2002) which is accessible via internet (<http://w3lamc.umbr.cas.cz/PlantSat>).

Although the genome of *Phaseolus* is one of the smallest among legumes (Bennett and Leitch, 1995), it is still expected to contain considerable proportion of repetitive sequences. Only a very limited number of *Phaseolus* repeats have been isolated and characterised so far, including rDNA genes, a family of retrotransposons Tpv2 (Garber et al., 1999), and a mini-satellite sequence OPG9-130 (Metais et al., 1998). Thus, we propose to screen for repetitive sequences to isolate representative collections of both dispersed and tandemly organised repeats. The following techniques will be used:

- Screening short-insert shotgun genomic libraries of total genomic DNA using the rapidly renaturing fraction (Cot-1) of genomic DNA as probe. Since size-fractionated DNA will be used for the library construction, the hybridisation signals will reflect copy numbers of cloned fragments in the genome and will be used for identification of repetitive sequences.
- Cloning and shotgun sequencing of Cot-1 and Cot-0.1 fractions of genomic DNA in order to identify the most abundant classes of genomic repeats (usually satellite DNA sequences).
- Performing genomic self-priming (GSP-) PCR as described by Macas et al. (2000). This technique is designed to specifically amplify and clone tandemly organised repeats.
- Computer analysis of novel sequences obtained above.

The newly isolated repeats will be sequenced and characterised with respect to their copy numbers, genomic organisation and distribution in *Phaseolus* and other legume species. Full-length clones of very long repeats (mostly retro-elements) will be isolated from available BAC or phage libraries based on their partial sequences obtained in the primary screening. The data obtained from these experiments will be used in several ways:

- A computer database containing *Phaseolus* repeats will be established and made available through the Internet, so that the repeat sequences can be used by other participating groups for identification of ESTs or other clones bearing repetitive sequences, and for masking DNA repeats during the assembly of contigs from sequenced clones.
- Clones of selected repetitive elements will be made available as probes for *in situ* hybridisation on mitotic or polytene chromosomes and for DNA fingerprinting of various *Phaseolus* species. This should provide tools for cytogenetic characterisation of karyotypes and for assessing phylogenetic relationships among individual species and cultivars, respectively.
- The repetitive sequences will be studied with respect to their evolutionary dynamics and possible role(s) in the genome. Comparative analyses of *Phaseolus* repeats with those from other well-studied legumes (*Vicia*, *Pisum*) will be performed.

Czech Republic (IEB/O – Jaroslav Dolezel)

Physical and cytogenetic mapping

Identification of individual chromosomes in *Phaseolus* is difficult due to similar morphology and lack of distinct chromosomal landmarks. In some plant species, fluorescence *in situ* hybridisation (FISH) has been employed using repetitive DNA sequences as probes to identify individual chromosomes. This application relies on the availability of repetitive sequences with specific distributions. BAC and FISH clones can be used to generate chromosome- or arm-specific probes. The main advantages of using large-inserts are easy detection, strong signals, and the possibility of comparative studies. Thus physical mapping of molecular markers *via* BAC and FISH can play critical roles in mapping wild relatives and progenitor species for which linkage maps do not exist.

The availability of BAC libraries of *P. vulgaris* makes possible the construction of a physical cytogenetic map. We will screen an existing bean BAC library

using a set of molecular markers representing each genetic linkage group, including existing RFLP, as well as EST and SSR markers that will be generated within this project. Markers evenly distributed throughout the genome and/or linked to important genes will be used. Depending on the type of marker, the screening will be performed either by hybridisation to DNA arrays or by PCR using a pooling strategy. Positive BAC clones will be fingerprinted to confirm the copy number of the probe loci and to eliminate false positives. Sequence-tagged BAC clones will be localised on mitotic chromosomes using FISH. In cases where two BAC clones localise to the same site on a chromosome, physical distance will be estimated by FISH on stretched mitotic chromosomes or by fibre-FISH and compared to the genetic distance. Mapped BAC clones will be hybridised to cDNA arrays to identify gene-rich clones. The arrays will be prepared from existing cDNA libraries and from cDNA libraries obtained within this project (see Table 8). Selected BAC clones will be candidates for preferential sequencing and gene discovery.

This work will result in:

- Generation of chromosome- and arm-specific cytogenetic markers.
- A framework of sequence-anchored ‘seed’ BAC clones covering the whole genome.
- Integration of genetic linkage and physical cytogenetic maps.
- Orientation of genetic linkage groups with respect to chromosome arms.
- Comparison of genetic and physical distance for selected markers.
- Identification of gene-rich BAC clones for rapid gene discovery.
- Determination of the chromosomal distribution of interesting genes.

Knowledge gained this way will allow comparative analysis of chromosome structure, gene synteny, domestication and evolution within the genus *Phaseolus* and to analyse the extent of colinearity with other species.

France (INRA/M – Jean-Jacques Drevon)

Tolerance of symbiotic nitrogen fixation to phosphorus deficiencies

In both tropical and mediterranean regions of Africa and Latin America, symbiotic nitrogen fixation (SNF) is often limited by such soil constraints as low phosphorus availability, drought or salinity. Although

beans are often considered poor N₂-fixing legumes, high N₂-fixing lines have been found in Latin America. Some can express their full SNF potential despite low soil P particularly by increasing the permeability of nodules to O₂ diffusion and proton efflux. Low permeability of nodules to O₂ diffusion and ion-exchange is associated with P deficiencies. Cytological observations suggest that variations in nodule permeability are due to reversible, osmoregulated contractions of inner-cortical cells of nodules that fine-tune the N₂ fixation process. We have initiated a search for genes that control SNF under conditions of low soil P. Lines possessing high phosphorus use efficiency (PUE) and good SNF ability have been selected and crossed with widely grown cultivars. A group of 20 RILs (Recombinant Inbred Lines F8) from one of these crosses, BAT477 (high SNF and PUE) x DOR364 (well adapted in Central America and the Caribbean as well as tolerance to BGMV virus), were selected in multi-year field trials. These lines have been genotyped using RAPD, SCAR and microsatellite markers and phenotyped in field trials under drought conditions at various sites across Cuba and Mexico. A genetic map has been constructed for this population and a set of quantitative trait loci (QTLs) have been identified that affect PUE and SNF. Future work will determine which candidate genes are responsible for the variation in PUE and SNF. The candidate genes will be sought using differential display techniques as well as from the analysis of nodule cortex cDNA libraries and DNA microarrays that prepared during the course of the project (see Table 9).

Phenotypic characterisation will use the following methods:

- Measurement of gas and ion exchange on intact nodulated roots of hydro-aeroponically grown plants to quantify the nodule conductance to O₂ (g_{no}), (which is linked to nitrogenase activity and proton efflux) will be made. This way we will be able to relate the kinetics of changes in g_{no} and H⁺ efflux to variations in rhizospheric O₂ concentrations (Drevon and Hartwig, 1997; Ribet and Drevon, 1996; Tang et al., 2001).
- Image analysis of nodule cortex parenchyma in order to correlate cell structural and morphometric features with immunolocalisation and *in situ* hybridisation of molecular probes. This way we will be able to correlate expression of genes in the nodule cortex with the physiological measurements described above (Serraj et al., 1998; Vadez et al., 1999).

France (LPPM/O – Thierry Langin, Valérie Geffroy)

Anthracoze and beans

Our laboratory is involved in the genetic and molecular analysis of the interaction between *Phaseolus vulgaris* and the pathogenic fungus *Colletotrichum lindemuthianum*, causal agent of anthracnose (see Geffroy et al., 1998, 1999, 2000). Independent and complementary projects are underway on both the host plant and the pathogen. In *P. vulgaris*, we are mostly interested in the evolution of disease resistance (R) genes in response to pathogen selection pressure. The interaction between *P. vulgaris* and *C. lindemuthianum* constitutes a good model system for the study of the molecular mechanisms underlying the evolution of R genes because of:

- The existence of divergent and well characterised bean gene pools.
- The occurrence of many specific resistance genes.
- The existence of co-evolution phenomenon between the fungus and its host at the level of the centres of diversity of the plant.

A – Identification of the B4 resistance-gene cluster

The genomic distribution of both specific R genes and R QTLs was studied using a recombinant inbred line (RIL) population derived from a cross between parents chosen to represent the two major *P. vulgaris* gene pools: BAT93 (Mesoamerican) and Jalo EEP558 (Andean). This RIL population, developed by the group of P. Gepts (pp. 104–108), is being used to construct an integrated linkage map of common bean. Seven specific R genes (four Andean and three Mesoamerican) were identified and mapped to four loci (Geffroy et al., 1999). Ten genomic regions involved in partial resistance against two different strains were identified (Geffroy et al., 2000). Four QTLs co-localise with specific R genes. These QTLs may therefore share structural and functional relationships with specific R genes. Co-localisation of QTLs with defence genes was also observed. Clustering of resistance specificities against *C. lindemuthianum*, against other pathogens and QTLs, as well as clustering of resistance gene analogs (RGA) provided evidence that R loci are complex at both the genetic and molecular level.

A particularly complex locus was identified on linkage group *B4*. This cluster, named the *B4* R gene cluster, contains:

- Two Andean and one of Mesoamerican R specificity.

- A family of RGAs of the nucleotide binding site type (PRLJ1 family).
- Two QTLs of Andean and Mesoamerican origin.

Co-localisation of Andean and Mesoamerican R specificities suggests that this locus existed prior to the separation of the two major *P. vulgaris* gene pools. The molecular dissection of this locus in both BAT93 and JaloEEP558 should bring improved understanding of co-evolution phenomenon at the molecular level.

B – Molecular tools to study the B4 resistance-gene cluster

In order to isolate expressed resistance gene analogues (RGAs) corresponding to the R specificities of the *B4* locus, cDNA libraries have been constructed from infected leaves for both BAT93 and JaloEEP558 (Ferrier-Cana et al., 2003). Genomic libraries were also constructed from the BAT93 and JaloEEP558 DNA partially digested with *Sau3A* and inserted into the lambda FIX vector phage (inserts from 15 to 20 kb). These four libraries have been screened with the PRLJ1 probe specific to the *B4* R gene cluster.

C – Molecular basis of host-pathogen co-evolution

Sequencing has revealed that the R genes present at the *B4* R cluster encode putative R factors belonging to the Nucleotide Binding Site–Leucine Rich Repeat (NBS–LRR) class of disease R proteins. This is the prevalent class of disease R genes identified in plants. Currently, 30 NBS-LRR-encoding R genes located at the *B4* R cluster have been completely sequenced from BAT93 and JaloEEP558. The comparative analysis of these sequences is underway. No molecular signature of Andean and Mesoamerican R-like genes was identified. Consequently, the co-evolution process seems to be governed by minor molecular changes. Furthermore, family members within one haplotype (paralogues) are not more similar to each other than they are to those from the other haplotype (orthologues). Therefore, concerted evolution did not lead to homogenisation of sequences within a particular haplotype.

D – Future directions

- Test the functionality of the candidate disease R genes using an *Agrobacterium tumefaciens* transient expression assay.
- Screen a *P. vulgaris* BAC library for the *B4* R gene cluster.
- Study the molecular diversity of the second half of the LRR encoding region of the gene in wild genotypes of *P. vulgaris* from the three centres of

diversity. Study the *B4* R cluster in *Medicago truncatula* in order to assess the evolution of the *B4* R cluster on a longer timescale.

France (CERMAV-CNRS – Eric Samain, Hugues Driguez)

The micro-symbionts of *P. vulgaris* constitute a heterogeneous group of bacteria. At least five different species belonging to the genera *Rhizobium* and *Sinorhizobium* have been identified from bean nodules. These different species produce different nodulation factors that show important structure dissimilarities. For example *R. etli* produce acetyl-fucosylated Nod-factors whereas *R. tropici* factors are sulphated at the same position. It is thus of great interest to have library of pure Nod-factors that are recognised by *Phaseolus* spp.

In the last few years we have developed a method for the synthesis of structurally defined Nod-factors. To do this, the chito-oligosaccharide backbone carrying suitable decorations is first produced by genetically engineered *Escherichia coli* strains that express heterologous rhizobial nodulation genes (Samain et al., 1997, 1999). Then the lipid chain is added by chemical acylation yielding synthetic Nod-factors (Gressent et al., 1999). This process can be scaled-up for the synthesis of large quantities for agricultural applications.

This method has been used to synthesise sulphated tetramers that are analogues of *R. meliloti* Nod-factors. Here we propose to synthesise the main structures that are produced by the different microsymbionts of *P. vulgaris*.

Synthesis of sulphated pentamers

We have shown that co-expression of *R. meliloti* *nodBC* and *nodH* genes in *E. coli* results in the biosynthesis of sulphated chitotetraose that is specifically *N*-deacetylated on the non-reducing residue. By using a *nodC* gene from a pentamer producing rhizobia (such as *Azorhizobium caulinaudans*, or *Rhizobium* sp. NGR234) we should be able to obtain the sulphated pentameric precursors for the synthesis of *R. tropici* Nod-factors. Chemical acylation with an appropriate fatty-acid chain will yield the target molecules.

Synthesis of acetyl-fucosylated pentamers

We have recently shown that *E. coli* can be metabolically engineered to allow the *in vivo* synthesis of fucosylated oligo-saccharides (Dumon et al., 2002).

Co-expression of the *nod*-gene that is responsible for fucosylation (*nodZ*) with *nodBC* should thus result in the production of chito-oligo-saccharides fucosylated at the reducing terminus. Introduction and expression of acetyltransferase gene *nolL* should lead to the synthesis of *R. etli* Nod-factor precursors.

Availability of Nod-factors

All synthesised Nod-factors will be made available to the Phaseomics community.

Germany (UG/G – Wolfgang Streit)

A description of our work and the importance of vitamins in bean nutrition is given on page 60. In Phaseomics, we will:

- Isolate and biochemically characterise *bio1* and *bio4* genes coding for DAPA-aminotransferase and dethiobiotin synthase, respectively, from *Phaseolus* plants. This will be done by hybridisation with known *bio*-genes and sequencing of complete BAC clones.
- To characterise the expression patterns of the isolated genes and evaluate the basic environmental factors affecting their expression.
- Explore the role of biotin bean metabolism, by identifying other biotin regulated genes such as biotin transport genes, a biotin biosynthesis regulator (*birA*), biotin dependent carboxylases, etc.

Italy (PIN – Roberto Papa and Phaseolus Italian network)

The *Phaseolus* Italian Network (PIN) has been formed to integrate and promote the different perspectives and projects among six Italian laboratories working on molecular biology, genetics of conservation, evolution, population genetics, plant breeding and agronomy of *Phaseolus* spp. Groups involved include those of Roberto Papa in Ancona (UNIAN) who co-ordinates the project, Pierluigi Spagnoletti Zeuli, in Potenza (UNIBAS), Gian Piero Soressi and Renato D'Ovidio in Viterbo (UNITUS), Andrea Carboni in Bologna (ISCI), Valeria Negri in Università degli Studi di Perugia (UNIPG), and Giovanna Attene in Sassari (UNISS). Phaseomics activities will be conducted by all partners and organised in five work-packages (STSs, ESTs, transformation, resistance to biotic stresses, and mapping populations), each one under the responsibility of a different partner.

- UNIAN (Papa) focuses on gene flow between wild and domesticated populations. Loci of interest include those involved in domestication and disease resistance, natural selection mapping and influence of mating system on shaping the genetic diversity in beans. Here they will develop STSs and SSRs from appropriate populations.
- UNIBAS (Zeuli) works on plant genetic resources and population genetics. In Phaseomics their focus will be on biochemical and molecular characterisation of genetic diversity in local bean populations.
- UNITUS (Soressi) studies the genetics of resistance to biotic and abiotic stresses. In Phaseomics, the team will work on the *in vitro* induction of adventitious shoots from meristematic explants of *P. vulgaris* and *P. coccineus* as part of an on-going effort to set up reliable genetic transformation protocols.
- UNITUS (D'Ovidio) works on the characterisation of the molecular events underlying plant responses to biotic stresses. In particular, the research is focused on clarifying the involvement of the Polygalacturonase Inhibiting Protein (PGIP) that limits fungal colonisation of plant tissue. In Phaseomics the research group, in collaboration with the University of Rome 'La Sapienza' (Cervone and De Lorenzo), will concentrate their efforts on defining the structural and functional characteristics of the bean PGIP locus.
- ISCI (Carboni) are concerned with the quality of agricultural products and the environmental compatibility of agricultural techniques. Beans suitable for mechanical harvest, for freezing and for fresh market have been produced (varieties 'borlotto' and 'cannellino'). In Phaseomics, the group will study the genetic basis of inheritance of disease resistance. The occurrence of physiological races will be investigated, the source of resistance identified, and screening of segregant populations for resistance to nematodes (*Meloidogyne incognita* and other spp), halo blight (*Pseudomonas savastanoi* pv. *phaseolicola*), Rhizoctonia, etc. will be performed.
- UNIPG (Negri) has a relational database and a collection of over 100 *Phaseolus* accessions that have been almost completely characterised. Their experience is in the genetics of reproduction and in the molecular characterisation of the pulses (including *Phaseolus*). In Phaseomics they will focus on the assessment of genetic variation of landraces

during on-farm conservation and reproduction under different environmental conditions.

- UNISS (Attene) focuses on plant genetic resources, population genetics as well as the co-evolution of plants and pathogens. In Phaseomics they will work on the biochemical and molecular characterisation of genetic diversity in Italian bean populations.

Population genetics, molecular biology and plant breeding

In order to improve crop species such as common bean that were subjected to severe genetic bottlenecks during domestication, (Sonnante et al., 1994; Papa and Gepts, 2003), it is important to exploit the wild germplasm using molecular tools (Tanksley and McCouch, 1997). The distribution of diversity in populations results from the joint effects of evolutionary forces and demographic factors, including random drift, selection, recombination, mutation, gene flow and the mating system. Genetic drift and migration influence all loci equally in the genome but selection affects only target loci (Kreitman and Akashi, 1995). The domestication bottleneck is limited to genomic regions containing genes and QTLs for domestication. At the same time, an increase of differentiation (F_{ST}) between wild and domesticated populations occurs for DOM as compared to UN and ND markers. Thus differentiation between wild and domesticated populations as well as the reduction of diversity of the domestication bottleneck is limited in genomic regions containing genes controlling most traits of the domestication syndrome (such as shattering, seed dormancy, photoperiod sensitivity, and determinate type). In these genomic regions, molecular markers present a very low polymorphism within domesticated form.

Molecular markers linked to genes involved in the genetic control of the domestication syndrome would be a perfect tool to select wild genotypes for plant breeding programmes aimed at introgressing the genetic diversity of wild populations into the domesticated varieties.

ESTs cDNA libraries will be constructed from mRNA isolated from young ovules, immature pod teguments and seeds using a domesticated (Midas) and a wild genotype (G12873), the parents of the RI population used to map traits associated to the domestication process (Koinange et al., 1996) and sequence the cDNA clones for markers development and SNPs

identification and screening. The main target traits are shattering, dormancy and drought tolerance. In collaboration with others of the PIN and Phaseomics consortia, we will study the expression and function of gene sequences (ESTs) of interest, cloned from *Phaseolus*, in homologous (depending on the availability of an efficient transformation protocol), and heterologous (e.g., *Lotus japonicus*) model systems.

Transformation We are evaluating the morphogenic capacity of apical meristems from dry seed embryos to form adventitious shoots on media containing combinations of TDZ and 2,4-D (*P. coccineus*) or BAP (*P. vulgaris*). Higher regeneration frequencies are found with *P. coccineus* (cv. Venere) than *P. vulgaris* (cv. Montecarlo). Other possible morphogenic tissues have been examined including layers of cotyledonary nodes from cv. Venere. First results show good proliferation (8–9 shoots per explant after four sub-cultures). Since this system appears to be reliable for transformation of *P. coccineus*, attempts are being made to transform the plant using *A. tumefaciens* based vectors.

Resistance to biotic stress Polygalacturonase Inhibiting protein (PGIP) is a plant cell-wall protein that is able to control endo-polygalacturonase (PG) activity during the initial step of pathogenesis both by limiting PG activity and by favouring the accumulation of pectic fragments, the oligogalacturonides (OG), able to elicit a number of plant defence responses. PGIP genes encode proteins with a Leucine Rich Repeat (LRR) structure that is typical of a number of plant resistance genes. These genes are organised in gene families and their encoded products may possess diverse specificities against fungal PG purified from different phytopathogens. Structural and functional studies show that the recognition specificity can be affected by single amino acid substitutions within the LRR region (De Lorenzo et al., 2001). The aim of this project is to clarify the role that PGIP and the signals regulated by its activity have in the recognition events between beans and micro-organisms. Knowledge of the sequence features in this 140 kb region help the population genetics studies proposed by the other groups. Information on a large set of PGIP genes will be used to characterise variability within the bean germoplasm and related species, and possibly to identify PGIPs with novel recognition specificities towards fungal PG.

Mapping population An RI population ($\cong 1500$ lines) is being developed from BAT93 \times Jalo EEP558 crosses. Although the bean genome has been extensively mapped (Freyre, et al., 1998; Nodari et al., 1993), we feel that it is necessary to supplement the number of existing RILs derived from the BAT93 \times JALOEPP558 crosses. This work will be co-ordinated by Andrea Carboni (ISCI-Bologna).

Italy (CNR/ISPORT – Roberto Bollini, Bruno Campion, Lucia Lioi, Angela Rosa Piergiovanni, Francesca Sparvoli)

Amongst the major factors that affect nutritional value (and technological properties) of beans are the storage proteins that accumulate in the seed during maturation. These proteins are very abundant, accounting for up to 80% of protein content of the seed. Interestingly the health benefits of consuming legumes tend to be correlated with some single storage proteins (Messina, 1999). In addition, their abundance makes them a good model system to study protein synthesis and accumulation in plant cells (Vitale and Bollini, 1995). All members of this research group have extensive experience in bean research. Our collaboration is mainly focused on the study of biodiversity of storage proteins. A large number of wild and cultivated accessions have been analysed, and a collection of genotypes in which each major storage protein varies in abundance has been established. Current work focuses on different aspects of bean storage proteins:

- Francesca Sparvoli and Roberto Bollini (Istituto di Biologia e Biotecnologia Agraria, CNR, -IBBA-, Milan) investigate the role of different kinds of stresses (inhibition of glycosylation, reducing agents, heat treatment, calcium ionophores) on storage protein folding in the endoplasmic reticulum (ER) (Sparvoli et al., 2000). This compartment is extremely important in developing bean cotyledons, whose major function is to accumulate and compartmentalise secretory storage proteins. Correct folding of newly synthesised proteins in the lumen of the ER is a fundamental prerequisite for their transport to other cellular compartments. Misfolded proteins, if not refolded by resident chaperones, are destined for degradation or to form aggregates in the ER. In both cases these events detrimentally affect the function, localisation and, in the case of storage proteins, eventually the amount of proteins that are accumulated in the seed. We will identify the func-

tion of genes/proteins involved in mechanisms that cotyledonary cells activate in response to protein misfolding in the ER. To this purpose, developing bean cotyledons will be used to perform transcript and protein analysis by means of cDNA differential display and proteomic tools respectively.

- Lucia Lioi and Angela Rosa Piergiovanni (Germplasm Institute, IG/CNR, Bari). Included amongst the major bean storage proteins are lectins and lectin-related polypeptides. A multi-gene family that segregates as a single locus encodes both types of proteins that vary in type and abundance with the genotype. Currently, we are interested in understanding the molecular evolution of this locus in common beans and other bean species (Lioi et al., 1998; Sparvoli et al., 2001). PCR-based cloning of the coding sequences of the different members of the gene family (using both wild or domesticated lines) of different origins (Andean, Mesoamerican, and intermediate) will be continued. The new sequences will then be used for molecular evolutionary studies and phylogenetic analyses.
- Bruno Campion (CNR/ISPORT, Salerno). Based on the data so far obtained on biodiversity studies, we are developing bean breeding-lines differing in seed storage-protein profiles (Campion et al., 1998). Each variant will provide useful information about all possible physiological interactions between its seed storage protein and the genetic background of the host (Confalonieri et al., 1992). The molecular bases of the different storage protein profiles will be analysed.

Another major qualitative trait of the seed is its content in phytic acid. Because phytic acid sequesters P, most seed phosphate is stored as a phytate complex. Despite this, phytic acid lowers the absorption of micro-nutrients and is responsible for the high load of phosphate in the animal faeces. In soybeans, the phytic acid content can be lowered by chemical mutagenesis. Interestingly, lower levels of phytic acid correlate with lower levels of raffinose, compounds responsible for flatulence (Hits et al., 2002). One of the most promising breeding lines recently developed has been subjected to chemical mutagenesis and the progeny will be analysed for phytic acid content. If low phytic acid mutants will be obtained, the molecular bases of the mutation will be analysed.

- IG and CNR/ISPORT. Major research activity at the Germplasm Institute involves evaluation of biodiversity of several cereals and legumes. LL

and ARP have studied the biodiversity in the *Phaseolus* genus for several years (Limongelli et al., 1996; Lioi and Hammer, 1993). These studies have been carried out in collaboration with regional organisations and are aimed at the characterisation, evaluation and promotion of 'on-farm' maintenance of local populations (Piergiovanni et al., 2000). Our involvement is aimed at the genetic recovery of local and old varieties threatened with extinction. Analysing seed storage protein profiles and RAPD or SSR markers will be used to investigate the genetic variability present in the populations of each cultivar.

Malaysia (MBC/M – Farida Shah)

The Malaysian beans genomic group (MBGG) consists of five laboratories – from the Melaka Biotechnology Centre (MBC), the Universiti Kebangsaan Malaysia (UKM), from the Universiti Putra Malaysia (UPM), from the Universiti Sabah Malaysia (USM) and from the Malaysian Agricultural Research Institute (MARDI). Within MBGG we have expertise in molecular studies of the expression of genes involved in fatty acid biosynthesis in oil palms (Shah et al., 2001), genetic manipulation of the fatty acid composition (Shah et al., 2002), genetic enhancement of disease and pest resistance in oil palms, genetic analysis of floral development (especially to look for floral abnormalities in oil palms), as well as EST analyses of genetic traits in oil palms, bananas and melons. Differential display has been used to isolate tissue specific clones and genes from mesocarp (Shah and Cha, 2000), kernel (Shah and Cha, 2001), leaves, flowers, etc. of oil palms. Micro-arrays have been used to follow expression of ESTs in flowers and roots. Membrane-based micro-arrays have already been used to study the expression of oil palm genes. Currently, we have the capacity to sequence 800 clones (ESTs) a day (64 000 bp). MARDI is involved in the breeding of the beans.

In Malaysia, common beans (80% of which are destined for the export market) are only grown on a small scale. Dwarf varieties have been cultivated but without much success. The main commercial cultivars are MK12 and MK13.

Floral and pod development

Little is known about the molecular basis of floral and seed development in *Phaseolus* spp. Accordingly, our contribution to Phaseomics will be to construct cDNA

libraries from various stages of flower and pod development (see Table 9). After random sequencing a large number cDNAs, selected clones will be used to fabricate micro-arrays. These micro-arrays will be used to examine gene expression during each stage of flower and pod development by hybridisation against labelled RNA/cDNAs. Genes that are stage-specific will be identified. Once a base line of modulation of gene expression during each stage of development has been obtained, changes in gene expression that result from various environmental stimuli will also be analysed.

Pest and fungal resistance

All plants possess a certain degree of resistance to insects. This inherent resistance results from various defence mechanisms, including a wide range of noxious secondary metabolites produced by the plant (Schuler et al., 1998). Individual plants within one genus, or even within one species, vary in their level of insect resistance, a fact long used by plant breeders to increase the insect resistance of crop cultivars. These different levels of resistance are related to expression of the specific genes in particular plants. Many different genes confer insect resistance in various plant species, and many more are expressed after insect attack (Pickett et al., 2001). Identification and manipulation of insect resistance genes in plants, offers certain advantages over conventional insecticides, such as more-effective targeting of insects protected within plants, greater tolerance of adverse weather conditions, fast biodegradability, reduced operator exposure to toxins and financial savings (Mitchell-olds et al., 1998). Widespread use of bioinsecticides should also lead to a reduction in the use of broad-spectrum insecticides, thereby extending the useful life of these compounds and reducing the ecological damage they cause (Baldwin et al., 2001). Here we will identify genes expressed during pest and fungal attack of flowers and pods using micro-arrays.

Beans will be treated with jasmonic acid, salicylic acid or wounding prior to mRNA extraction since these agents have been reported to mimic insect and pathogen attacks. A DDRT-PCT method will be used to identify transcripts specifically expressed in treated plants. mRNA obtained from untreated plants will be used as a control. cDNA clones whose expression is up-regulated in an insect resistant manner will be sequenced, and analysed. Northern/micro-array analyses will then be used to study the expression pattern of the ESTs.

Transformation

As tissue culture and transformation protocols will need to be adapted to Malaysian (and therefore humid tropical) bean cultivars, we will:

- (a) Screen for explants with a view to optimising callous and embryo formation;
- (b) Screen different target tissues for transformation using vectors containing constitutive and/or tissue specific promoters linked to suitable reporters gene as well as chitinase gene;
- (c) Different transformation protocols (e.g. biolistics or *Agrobacterium tumefaciens*) will be compared;
- (d) Optimise regeneration protocols, and;
- (e) Analyse the efficiency of transcription of the integrated genes.

México (CIFN/UNAM – Gina Hernández, Miguel Laña)

Functional genomics of symbiosis

R. etli is the natural symbiont of *P. vulgaris*. Both the legume and the micro-symbiont originated in the Americas and have co-evolved together for centuries (see *Rhizobium*-legume symbioses, p. 69). The Nitrogen Fixation Research Center (CIFN) in Cuernavaca has initiated collaborative genomic projects on both the bacteria and the plant. Julio Collado-Vides, Guillermo Davila, Rafael Palacios and Jaime Mora will complete the DNA sequence of *R. etli* strain CFN42 that, in addition to a chromosome, contains six large plasmids.

The work of our groups centers on carbon/nitrogen metabolism in bean nodules induced by *R. etli* (Cammas et al., 2002; Lara et al., 1984; Ortega et al., 1992; Padilla et al., 1987; Silvente et al., 2002). More recently a collaborative project on symbiotic functional genomics of *P. vulgaris* has been initiated that includes our groups, Federico Sánchez (Institute of Biotechnology, Cuernavaca, IBC/UNAM), and Carroll P. Vance (University of Minnesota – USDA, St. Paul, USA). Furthermore, Jean-Philippe Vielle-Calzada (CINVESTAV-Irapuato) has agreed to provide the initial constructs for insertional mutagenesis.

An efficient and reliable genetic transformation system is crucial to any genomic project. Towards this end, we have established a protocol for *in vitro* regeneration of the five *P. vulgaris* cultivars that are most widely grown in Mexico: Negro Jamapa 81, Flor de Junio, Americano, Flor de Mayo and Peruano. The explants used are the cotyledonary nodes

from germinated seedlings. Regeneration occurs via direct organogenesis. An average of two shoots were separated and rooted from each explant. Microscopic analyses indicated multiple shoot formation however. The *in vitro* regeneration system established for Negro Jampa 81 was used for genetic transformation using *A. tumefaciens*. A low percentage of putative primary transformants (T_0) was obtained, and they showed the presence of the transgenes by PCR analysis. After self-pollination, progeny from the T_0 was obtained but stable integration of the transgenes could not be detected in these plants. Establishment of the transformation procedures for different bean cultivars is being undertaken. In addition, reverse genetics in other plants has been used to complement the work in beans (Chichkova et al., 2001; Fuentes et al., 2001).

In Phaseomics we will:

- Construct cDNA libraries from bean nodules at different stages of development, from pods and from P-limited roots (see Table 8).
- Sequence several thousand ESTs.
- Integrate the EST's data into the Phaseomics databases.
- Use macro- and micro-arrays to analyse the bean transcriptome.
- Establish a system for genetic transformation in order to generate banks of bean mutants through random insertional mutagenesis and gene trapping. Analyse the global regulation of nitrogen/carbon metabolism in bean nodules.

México (IBt/UNAM – Federico Sánchez, Carmen Quinto)

Nodule organogenesis (Federico Sánchez)

Plant cells often respond to intra-cellular and extra-cellular cues by dynamically modifying their microtubule actin micro-filament cytoskeletons. Actin reorganisation in particular is necessary for or coincides with a variety of processes including cell division, cell elongation, plastid positioning, stomatal closure, cytoplasmic streaming, geotropism, circadian rhythms, polar growth of pollen-tubes and root-hair cells; stress adaptation; and signaling responses to wounding, symbiont mutualism or pathogen attack (Blaume et al., 2000; Cárdenas et al., 2000; Volkmann and Baluska, 1999). Since the actin cytoskeleton seems to play an important role in nodulation (Cárdenas et al., 1998; Sánchez et al., 1991) we will investigate the dynamic network of micro-filaments that re-organise during host-pathogen interactions (Staiger, 2000). The three

isoforms of root-actin resemble those of bean root-nodules approaching senescence. Mono-ubiquitylation of actin is common in *Rhizobium*-legume interactions as well as in a wide range of plant-pathogen infections (Dantán-González et al., 2001). Since this modification augments the stability of actin micro-filaments, we suggest that actin mono-ubiquitylation plays a key role in "immunity" against microbial infections. This is an ancient strategy shared by plants, insects and vertebrates (Nümberger and Scheel, 2001). Recently, we reported (in bean nodules), that a single profilin transcript gives rise to multiple isoforms (at least four) which are generated by phosphorylations on tyrosine residues (Guillén et al., 1999), providing strong evidence for the existence of tyrosine protein kinases in plants. Here we will examine some of these pathways using beans as the model system.

Nod-factors and signal transduction (Carmen Quinto)

We study the early signal transduction events induced by *Rhizobium etli* on the roots of *Phaseolus vulgaris* (Cárdenas et al., 1995). Of special interest are the dynamics of actin cytoskeleton, as well as oscillations in Ca^{2+} and other ions (Cárdenas et al., 1998, 1999, 2000). Among the most rapid responses of bean roots to the Nod-factors produced by rhizobia are the changes in membrane potential and oscillation of certain ions, notably Ca^{2+} , Cl^- and H^+ . To gain a better understanding of these ion fluxes in the *P. vulgaris*-*R. etli* symbiosis, we will examine different ion channel populations using planar lipid bilayers, and determine their role in Nod-factor signalling.

*México (IBt-UNAM/Alejandra Covarrubias;
INIFAP/Jorge Acosta)*

Molecular and cellular bases of the plant adaptive responses to water deficit.

We study the molecular mechanisms of adaptive responses to osmotic stress, adverse conditions that are frequently encountered and restrict growth of land plants. Our interest focuses on two main areas: (a) the functional characterisation of genes (and their proteins) involved in drought tolerance, especially the so-called *LEA* genes (Ingram and Bartels, 1996); and (b) the interaction between cell-wall proteins and plasma-membranes (PM) in response to osmotic stress. Two experimental models, are used – *Phaseolus vulgaris* and *Arabidopsis thaliana*.

Most *LEA* proteins are part of a more widespread group, which we call "hydrophilins". The criteria that are used to define hydrophilins are an excellent predictor of responsiveness to hyper-osmosis (Colmenero-Flores et al., 1997). Hydrophilins represent analogous adaptations to common stresses in such diverse organisms as prokaryotes and eukaryotes. Questions that are being addressed include: (a) how do the structural and physicochemical characteristics of hydrophilins relate to the largely unknown functions of *LEA* proteins?; (b) are hydrophilins a solution to a plant-specific problem, or to a more general one?; (c) do *LEA* proteins have protective properties?; and; (d) if they do, what protective function(s) are exerted during dehydration? Some answers to these questions have already been provided. One observation is that expression of a *lea* gene that we identified in *P. vulgaris* (*Pvlea-18*) (Colmenero-Flores et al., 1999; Garay-Arroyo et al., 2000) during dehydration is mostly independent of abscisic acid (ABA). It is also the first published example of where the 3'-region of a gene specifically participates in modulation of gene-expression in response to dehydration (Moreno-Fonseca et al., 2001). Additionally, in collaboration with J.-P. Vielle-Calzada (see México CINF/UNAM), we are employing the "gene trap" system in *Arabidopsis* to identify and isolate genes whose expression is modulated by water deficits. Two proline-rich proteins (p33 and p36), which accumulate in response to water deficits, have been identified that bind leaf protoplasts and PM vesicles. This binding can be inhibited by a peptide that contains the RGD motif, as well as fibronectin, suggesting that the PM binding protein has an integrin-like function whose natural ligands are p33 and p36. Characterisation of this interaction will be continued by isolating and identifying those proteins that bind p33/p36 to elucidate their roles in adaptive stress. Finally, in collaboration with Jorge Acosta at the Instituto Nacional de Investigaciones Agrícolas y Forestales (INIFAP), and with June Simpson at CINVSTAV [see México (CINVSTAV)], we are involved in the identification of molecular markers associated with drought resistance.

Participation in Phaseomics

Our main focus will be the analysis of pathogenic interactions and adaptation to drought.

Specific Objectives

1. Determination of the partial nucleotide sequences of cDNAs generated from mRNAs of roots of plants subjected to water deficits. The number of ESTs generated will correspond to at least 50% of the transcripts produced under these conditions.
2. Generation of an improved set of molecular markers through (a) the localisation of ESTs on the integrated linkage map of beans; (b) production of segregating populations for agronomic traits related to drought resistance and (c) the detection of additional AFLP markers closely linked to such traits.
3. Analysis of the sequence data using bioinformatic tools to predict gene functions, phylogenetic relations to other intra- or inter-specific (paralogous or orthologous) sequences, as well as the integration of this knowledge into genetic and/or physical maps. Given the anticipated average length of ESTs, we expect that about 80% of all genes will be represented with at least 30% of their entire nucleotide sequence. With this information, it will be possible to establish priorities for the cloning of relevant genes.

Goals

- Nucleotide sequence of \approx 15,000 ESTs, corresponding to those of abundant, less abundant and rare mRNA species expressed under drought conditions.
- Functional annotation of each EST, structural comparisons/predictions.
- Integration EST and AFLP markers into the genetic map.
- Association of molecular markers with agronomic traits.

México (CINVESTAV – Juan José Peña Cabriales)

Involvement of trehalose in drought tolerance

Trehalose plays a role in drought tolerance of rhizobial/legume symbioses, particularly in common beans. Nodulated plants that accumulate only small amounts of trehalose are poorly drought-tolerant, whereas those that accumulate higher concentrations are more resistant to drought stress (Fariás-Rodríguez, et al., 1998). To examine the eco-physiological role of trehalose in

symbiosis, we studied a tropical deciduous forest. Trehalose accumulated at the end of rainy season and the beginning of dry season, when the legumes began to flower. As a result, elevated concentrations of trehalose accumulate in the seeds, where they may be a determinant of the extreme longevity.

Different common bean genotypes, inoculated with various rhizobial strains that accumulate varying amounts of trehalose in nodules, as well as rhizobial mutants unable to synthesize trehalose, will be used to explore the clear correlation between trehalose synthesis and drought tolerance. At the same time, rhizobia that over-express trehalose synthesis from a strong constitutive or inducible promoter will be used as inoculants to test the effect of even higher levels of trehalose in nodules on drought tolerance. To dissect the role of trehalose in the longevity of seeds, trehalose levels will be measured in embryos and cotyledons. Artificial ageing and vigour tests will be performed on seeds containing different amounts of trehalose, obtained by screening the CIAT germplasm. cDNA libraries will be constructed from both cotyledons and embryos of developing seeds, ESTs sequenced, and micro-arrays made of candidate clones. Then, the effects of drought on trehalose metabolism in different bean accessions will be studied.

Quantification of nitrogen fixation in the field (with IAEA/FAO)

Many methods for measuring N_2 fixation, P uptake and water use efficiency in crops exist (Vera-Núñez et al., 2000). Mostly, these methods are based on yield increments. Isotopic techniques are particularly appropriate because they provide integrated values of the performance of crops directly in the field throughout the growth cycle. Field experiments will be coordinated and conducted in different countries with the aim of assessing N_2 fixation, P uptake from different sources, and water use efficiency by 'promising' bean genotypes inoculated with combinations of selected micorrhizal and rhizobial strains. Isotopic dilution (^{15}N , ^{32}P) as well as neutron probe techniques will be used. Participants wishing to use our services could either submit the material (seed and microbial strains) to Irapuato, where experiments will be undertaken or they could conduct the experiments under their own field conditions and send the samples to Irapuato, for isotopic analysis.

Mexico (CINVESTAV – June Simpson, Luis Herrera-Estrella)

An increasing number of viral, bacterial and fungal diseases can be effectively controlled using transgenic strategies. For this reason, our research at the Irapuato-Unit of the Centro de Investigacion y Estudios Avanzados is centred on the development of an efficient transformation system for beans as well as the sequencing of ESTs from plants grown under phosphate limiting conditions or from plants infected by *Colletotrichum lindemuthianum*. Progress in bean improvement has been slow since an efficient and reproducible transformation system has yet to be developed. The only well documented reports are those based on the bombardment of apical meristems. Unfortunately, these methods are intensive and have dramatically low efficiencies – only 0.02% of the regenerated plants transmit the introduced DNA to their progeny. Genetic engineering strategies, which rely upon the production of a relatively large number of transgenic plants are thus severely restricted. Efficient transformation protocols are therefore essential; especially for studying e.g. the *cis*-acting DNA sequences involved in tissue specific and environmentally induced gene-expression. In turn, these promoter sequences will be necessary to successfully produce transgenic plants with new agronomically important traits.

We have developed a tissue culture system that allows the production of embryogenic bean cell lines from which mature plants can be obtained at high frequency. Using these embryogenic cell lines and particle bombardment or *Agrobacterium*-based transformation systems, we have been able to produce Basta and hygromycin resistant plants. Although our results suggest that the transformation of embryogenic cell lines could become an attractive alternative for bean transformation, we still need to carry out Southern blot analysis of the T_1 progeny of the resistant lines to confirm that the resistant plants are indeed transgenic. We will continue these efforts to develop a high efficiency bean transformation system based on embryogenic cell lines.

Since ESTs represent genes that are transcribed under specific physiological or developmental conditions, one way to identify genes involved in particular processes is the construction of gene libraries from RNA extracted from plants subjected to specific environmental conditions and/or exposed to pathogens. As part of the Phaseomics initiative we will sequence

5000 ESTs of cDNA libraries constructed from mRNA obtained from plants grown under phosphate limiting conditions and plants infected with *Colletotrichum lindemuthianum*, the causal agent of anthracnose. Phosphate-limiting conditions and anthracnose have been chosen since they have been identified as two of the most important constraints limiting bean productivity worldwide.

The Netherlands (PRI/W – Jan-Peter Nap)

Plant Research International (PRI) is part of the Plant Sciences Expertise Group of Wageningen University and Research Center. Its research topics cover the whole chain from gene and genome analysis to design and implementation of agricultural production schemes. The co-ordinator's interests include the stability of plant (transgene) expression (Mlynárová et al., 1996), gene silencing (Hutvágner et al., 2000), development of novel approaches in statistical plant breeding (Nap et al., 1997), as well as genomics (Jansen and Nap, 2001). PRI operates a high-throughput DNA sequencing facility (Greenomics) that has been involved in the completion of the *Arabidopsis* genome sequence (*Arabidopsis* Genome Initiative, 2000) and a successful microarray facility (Aharoni et al., 2000).

Although PRI has no prior experience with *P. vulgaris* as object of research, its facilities, expertise and international focus well complement existing expertise and initiatives, notably those in the Genomics part of the Phaseomics framework. Contributions will include:

- EST analysis: production and EST analyses of a normalised library of aluminium-grown BAT93 *Phaseolus* roots/flowers; EST analyses of normalised and subtracted libraries (\pm high Al^{3+} ; \pm pathogen). From 1000 to 3000 EST's per library will be sequenced and annotated.
- Bioinformatics: PhaseoBase, a central database of all data generated by the consortium will be generated and made ready for mining by the consortium members. This database will be modelled on the XGI/ISYS system of the US-based National Center for Genomic Research (NCGR) with whom PRI collaborates.
- Expression profiling: PRI will produce microarrays for the consortium-selected ESTs for expression profiling of *Phaseolus* materials, preferably also using the available RIL populations. QTL analysis of microarray data combined with

mapping data is a novel approach to the isolation of QTL genes and possible identification of other QTL determining genes.

- Genome sequencing: sequencing and annotation of two BACs selected by other partners for the presence of interesting markers/genome regions.
- Proteo-Metabolo-Phaseomics: detailed analysis of the proteome and metabolome spectrum of selected *Phaseolus* materials.
- Functional Phaseomics: in collaboration with an East-European partner (Slovakia) further development and implementation of *Phaseolus* transformation protocols to be used in HTP gene silencing approaches (VIGS, RNAi).
- Detailed analysis of the *Phaseolus*/fungal/microbial pathogen interactions using fluorescence technologies and associated RNA profiling.

Puerto Rico (UPRM – Eduardo C. Schröder)

Improvement of the P. vulgaris-Rhizobium symbiosis in Puerto Rico

P. vulgaris is a major component of the diet of Caribbean peoples, including those of Puerto Rico. Local production does not satisfy the demand however, and a large proportion of beans are imported from the USA. Since bean production is optimum at about 21–24 °C, the best yields are obtained during the winter months of the northern hemisphere, or at higher elevations during summer. Heat-tolerant varieties have been selected to extend the bean-producing season (Fernández-Toledo et al., 1997). Similarly, the establishment of highly efficient, nitrogen-fixing nodules is limited by many factors (Buttery et al., 1997; Schröder, 1992).

The reported genetic variability in host traits that determine the amount of nitrogen fixed should be further exploited, particularly as new bean germplasm is available to farmers (Schröder, 1992). We will study the effect of introducing exotic genes on the nodulation specificity and nitrogen fixation capacity by crossing *P. vulgaris* with *P. coccineus* (runner beans) and *P. acutifolius* (teparty beans).

Biodiversity of strains occupying nodules (even on the same plant) has been widely demonstrated, and competition of introduced strains with local adapted ones is still a practical problem. Another goal is to study the molecular differences (by DNA fingerprinting) between strains isolated from nodules of land races as well as local cultivars and compare their symbiotic specificity. Soil samples will also be processed

in the laboratory to isolate new *Rhizobium* phages. Their host range and biological characteristics will be scrutinised.

Biological factors (including root diseases, microbial antagonism, predators, etc.) affect nodulation and nitrogen fixation. Co-inoculation studies of beans with rhizobia and other beneficial bacteria are promising (Burdman et al., 2000). Some bacteria show excellent biocontrol activity (Rosas et al., 2001) and are potential candidates for mixing with rhizobia in peat inoculants. Reduction of root-rot can lead to better nodulation (Perdomo et al., 1995). Furthermore, current research indicates that allelopathic compounds excreted by common tropical weeds can severely reduce nodulation. Further investigation in this area is needed to improve the bean symbiosis. Finally, in order to increase the BNF capacity of beans in farmers' fields, we will help a Haitian firm develop inoculants including biofertilisers for sale in the Caribbean.

South Africa (UWC/B – Chris Gehring and Graeme Bradley)

Stress responses – roles of natriuretic peptides

Natriuretic peptides are a well-studied class of vertebrate molecules that are involved in the regulation of ion and water transport in cells and whole organisms. Natriuretic peptides thus affect osmotically regulated processes and are an important contributor to homeostasis. A class of biologically active plant proteins that react with antibodies directed against a vertebrate natriuretic peptide, α -hANP, have been defined as novel plant natriuretic peptides that play a role in the regulation of ion and water transport across plant cells (Billington et al., 1977; Gehring, 1999). These novel immunoreactant plant natriuretic peptides have been named irPNPs. IrPNPs have been shown to promote stomatal opening (Billington et al., 1997), to rapidly and reversibly increase cellular cGMP-levels (Pharmawati et al., 1998, 2001), to modulate cation transport (Pharmawati et al., 1999) and bind specifically to cell membranes *in vitro* and *in situ* (Suwastika et al., 2000). IrPNPs also significantly enhance osmoticum-dependent water transport in mesophyll protoplasts (Maryani et al., 2001). Recently, two members of the irPNP family of molecules from *Arabidopsis thaliana* (AtPNP-A and -B) have been identified *in silico* and subsequently isolated by RT-PCR (Ludidi et al., 2002). In addition, we have also identified irPNP homologues in EST databases of *Medicago truncatula* and *Glycine max*

(Ludidi et al., 2002). Protein sequence analyses show that irPNPs occur in two sub-families; one found in both monocotyledonous and dicotyledonous plants and the other found only in dicotyledonous plants (Ludidi et al., 2002). In addition, irPNPs are closely related to CjBAP12 (a functionally undefined protein from citrus that is induced in response to blight infection). IrPNPs and CjBAP12 share a common ancestor, primitive glucanase-like molecules that are similar to fungal β 1–4 endoglucanases. Both irPNPs and CjBAP12 are related to the cell wall loosening expansins, although at least CjBAP12 has no expansin-like activity. Moreover, in keeping with their increased extracellular mobility and effects on cell membranes rather than the cell wall, irPNP-like molecules do not contain the wall-binding C-terminus of expansins. Importantly, irPNP-like molecules are present in conductive tissues suggesting that they are transported, an observation that is consistent with their role as systemic messenger.

We are currently using *Arabidopsis thaliana* to monitor transcriptional and translational control of irPNP expression and these studies will be extended to beans. We will also test for biological activities of recombinant proteins and/or selected domains *in vitro* and *in vivo*. Functional testing will include monitoring the effects on cation transport, osmoticum-dependent water transport, mobilisation of second messengers (e.g. cGMP), activity of ATPases as well as stomatal guard cell movement. Our major long-term programme is to first understand and then increase drought and salinity tolerance in legumes. Our research is strengthened significantly by ongoing and close collaboration with SANBI (South African National Bioinformatics Institute).

Spain (MBG-CSIC – Antonio M. De Ron and Marta Santalla)

Our work at the Misión Biológica de Galicia (MBG-CSIC, Pontevedra, Spain) is focused on:

- **Germplasm.** A large collection (1125 accessions) of wild and cultivated beans (*P. vulgaris* and *P. coccineus*) has been assembled through national and international missions in Europe and South America (De Ron et al., 1997). This material has been used in studying genetic variation, evolution, breeding and cropping systems. Some accessions form the basis of breeding lines (Escribano et al., 1994, 1997, 1998; Gil and De Ron, 1992; Rodiño et al., 2001b, 2002).
- **Cropping systems.** Monoculture and intercropping of beans with maize has been studied under different environments in the Northwest of Spain (Santalla et al., 1994, 1995, 1999a,b, 2001b). In addition, the rhizobial symbiont in the different systems has been evaluated in local landraces and breeding lines (Santalla et al., 2001c).
- **Bean evolution.** An analysis of the domestication process in wild Andean and antique landraces is being carried out by phenotypic, biochemical and molecular studies (De Ron et al., 1999). Furthermore, a secondary centre for diversification of common beans has been found in southwestern Europe. Variation in allozyme patterns revealed forms intermediate between the Andean and Mesoamerican genetic pools (Santalla et al., 2002).
- **Dry bean breeding.** This work focuses on the improvement of specific agronomic traits and seed quality (Escribano et al., 1997; Monteagudo et al., 2000; Rodiño et al., 2001a; Santalla et al., 1999b, 2001a), as well as on multiple resistance to diseases (BCMV, *Pseudomonas*, *Xanthomonas*). Selection is based on biochemical and molecular markers.
- **Scarlet bean breeding.** *P. coccineus* is widely cultivated in Spain. Accordingly, Spanish landraces have been evaluated for agronomical performance and seed sensorial quality (Martínez et al., 2002). Some breeding lines have been used in interspecific crosses.
- **Snap bean breeding.** A new project includes evaluation of pod quality in various landraces (e.g. yellow pods as demanded quality by the market).

Switzerland (LBMPS/GE – Bill Broughton and Xavier Perret)

Rhizobial determinants of effective nodulation of beans

Rhizobium sp. NGR234 nodulates common beans but the nodules are often ineffective (i.e. they do not fix nitrogen) (see Pueppke and Broughton, 1999). Undoubtedly, rhizobial genes exist that help control effectiveness since a number of isolates (*Rhizobium etli*, *R. tropici* and *R. leguminosarum* bv. *phaseoli*) fix large amounts of nitrogen with this plant (Michiels et al., 1998). A simple way of identifying these genes is to mass conjugate a e.g. *R. etli* cosmid library (cloned in a transmissible vector) into NGR234 and to use pools of the transconjugants to inoculate beans. Simply

by screening the inoculated plants for yellow- (non-fixing) or green-leaves (efficient in nitrogen-fixing) will identify pools of transconjugants, which contain *R. etli* genes that are able to confer the capacity to fix nitrogen on NGR234. Two, complementary methods will then be used to delimit the actual transconjugate(s) that is(are) responsible for this phenotype. One will be to isolate the occupants from the effective nodules, and from them, the cosmid in question. This method suffers from re-arrangements that are likely to occur amongst the different replicons in NGR234 (chromosome, mega-plasmid, symbiotic plasmid, introduced cosmid) during nodulation. For this reason, the cosmid pool that yielded the effective nodules will be sub-divided into smaller pools, which will then be used to inoculate and screen further bean plants. Each of these two types of experiments will be repeated until a cosmid (or a set of over-lapping cosmids) has been identified. Then, this cosmid(s) will be characterised first by complete sequencing, and then by mutational analysis. Methods of this kind have successfully been used to identify NGR234 genes that are involved in nodulation of various legumes (Broughton et al., 1984, 1986; Lewin et al., 1987).

Root-hair ESTs

Phaseolus species only fix low amounts of nitrogen when compared to other legumes (see Table 8). An important objective of 'Phaseomics' therefore is to ameliorate nitrogen fixation in beans. Detailed analysis of nodulation and nitrogen fixation in beans is thus essential to increase production of beans. Generally, root-hairs emerge at the apical end of some epidermal cells, and elongate by polar growth of the tip. Young, elongating root-hairs are extensively colonised by soil-borne micro-organisms. Rhizobia enter the roots (and occasionally adventitious-roots on the stems) of legumes, and induce the formation of highly specialised organs called nodules. Rhizobia present in the root nodules convert to an endo-symbiotic form, the bacteroids, in which dinitrogen is reduced to ammonia. Bacteroids within nodules contribute the majority of fixed nitrogen to the global pool.

In other words, symbiotic bacteria first contact the root-hairs of legumes. Obviously it is within this interface that early recognition events occur which largely control further development of the symbiosis. In our laboratory, we have developed methods for analysing the molecular changes that occur in root-hairs following inoculation with rhizobia (Krause et al., 1992, 1994; see Irving et al., 2000). Root-hairs are isolated

by flotation in liquid nitrogen, and the frozen tissue used for extraction of nucleic acids, proteins, etc. Messenger RNA can be isolated, cDNA libraries established, and selected clones sequenced. We will use these techniques to generate $\approx 5,000$ ESTs from both treated and untreated root-hairs as well as internodes.

Expression analysis of ESTs (transcriptomics)

Our laboratory helped pioneer studies on gene expression of bacteria that interact with plants (Fellay et al., 1995; Freiberg et al., 1997; Perret et al., 1999). We will use this expertise, along with all the EST sequence data generated by other groups in the project to construct micro-arrays. RNA will be isolated from all the tissues listed in Table 9, labelled and hybridised against the micro-arrays to study the expression of a large collection of ESTs. These data will be essential to understanding the physiology of bean growth and how the plants respond to the environment.

Proteomics of nodule development

Evidence is accumulating that the symbiotic signal transduction pathway involves changes in phosphorylation of a number of membrane-bound proteins in root-hairs (Irving et al., 2000; Kelly and Irving, 2001, 2002). We have developed ways to identify and isolate some of these proteins (Boukli et al., 2002). So far these methods have focused on individual proteins, but in collaboration with the Australian Proteome Analysis Facility (see Australia APAF, p. 79) full, proteome scale analysis of especially membrane proteins will be studied. Approaches of this kind have already been applied to thylakoid membranes (Hippler et al., 2001) and should thus also be applicable to root-hairs. Knowledge of how nodulation is regulated along with access to the controlling genes should permit the development of more efficient nodulation and nitrogen-fixing plants.

Coordination of the global project

In addition to the research listed above, LBMPS will coordinate the 'Phaseomics' project. At the scientific level this will involve collecting all the disparate information from the research laboratories, analysing it, and making it available on our web-site [www.phaseolus.net]. LBMPS will also be responsible for co-ordinating the raising of funds to support the international collaboration that will be necessary for the success of this project.

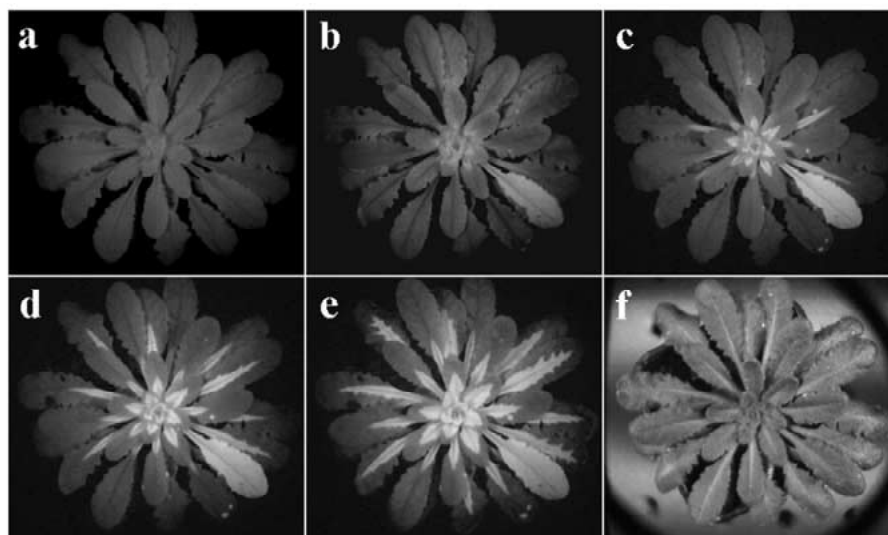

A.

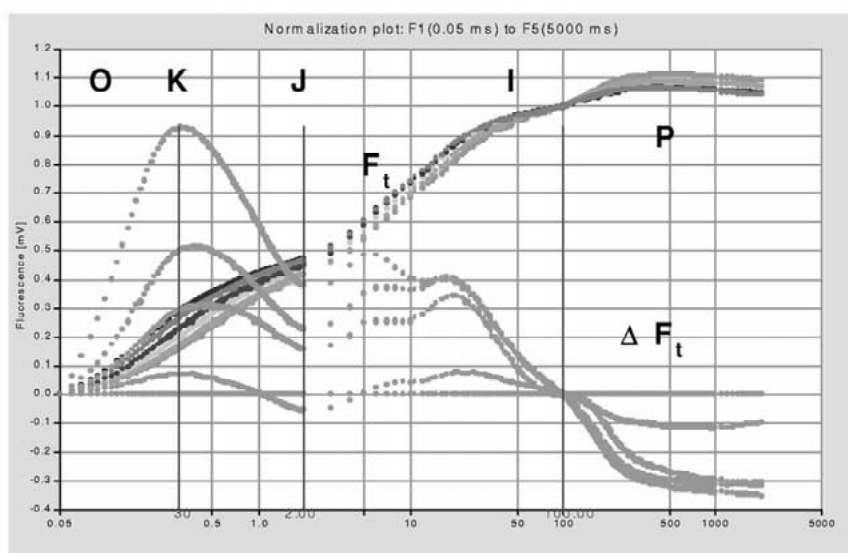

B.

Figure 6. A. Chlorophyll *a* fluorescence imaging of diuron transport in *Arabidopsis thaliana* leaves. Diuron (a herbicide, inhibits photosynthetic electron transport. As a result, light energy is dissipated as heat and fluorescence) was topically applied to one leaf that is discernible in panels b–e by its uniformly high chlorophyll *a* fluorescence. Diuron is first transported to the upper leaves. (a) The rosette before treatment; (b) 2 h after treatment (c), 4 h after application of diuron, the herbicide has spread to the petioles of lower leaves in the rosette; (d) 6 h after diuron application. The increase in chlorophyll *a* fluorescence has expanded into the upper leaves of the rosette and along the main veins of the lower leaves; (e) 10 h after application, diuron has spread to the side veins; (f) greyscale reflectance image of the treated *Arabidopsis* rosette. Further spreading of diuron along the side veins is evident. **B.** O-J-I-P-induction kinetics of chlorophyll *a* fluorescence in leaves of *Vigna unguiculata* plants grown in a nutrient solution containing 0.5; 1.0; 5; 10; 20 mM KNO₃ (F_t from top to bottom) along with the corresponding differences in kinetics of each treatment compared with plants grown in 20 mM KNO₃ (ΔF_t). Kinetic data are presented on a logarithmic time scale from 50 μ s to 2 s, and this period has been sub-divided into the O-J-I-P steps. The fluorescence traces were normalised between 50 μ s and 100 ms (measuring time 2 s per sample). A PEA fluorimeter (Plant Efficiency Analyser – Hansatech Instruments, Narborough Road, Pentney, King’s Lynn, Norfolk PE32 1JL, UK) was used. The increase in fluorescence intensity at 300 μ s is typical of nitrogen starvation.

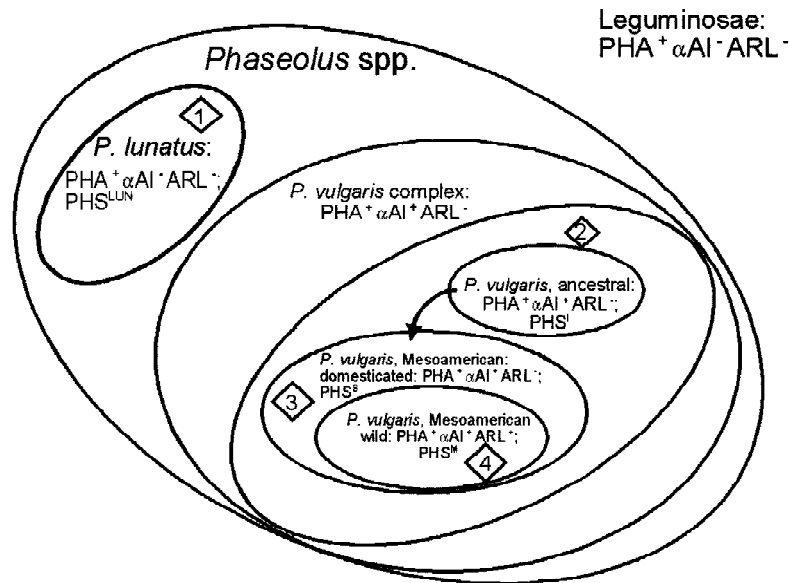

Figure 7. Evolutionary divergence among key taxa (labelled 1–4) in the *Phaseolus* genus. Each taxon is followed by a description of its phenotype for the APA locus (PHA: phytohaemagglutinin; α AI: alpha-amylase inhibitor; ARL: arcelin) and the PHS (phaseolin) locus. For further explanations, see text. For each of the four taxa, a BAC library is being developed.

Switzerland (BIOEN/GE – Reto Strasser)

Our goal is to establish functional behavioral patterns of living plants. As an index of plant health, we use the poly-phasic chlorophyll *a* fluorescence transient O-J-I-P (Srivastava et al., 1995; Strasser et al., 1995; Tsimilli-Michael et al., 2000). Fast fluorescence kinetics (10 μ s to 15 min) emitted by chlorophyll containing tissues are analysed using the so-called JIP-test. Typically, data are collected with a measuring time of \approx 1 s, a 10 μ s time of resolution and 12-bit digitalisation of the signal (Figure 6). As the JIP-test can easily be used to analyse plants under stress, it is a valuable tool for screening different phenotypes. JIP-test technology has been used in international projects dealing with pulses (in India), establishment of banks of stress-data (Australia), sugar cane and soybeans (South Africa), and drought stress of peas (Spain). Advantages of the JIP test (Strasser et al., 2000) include:

1. The short measuring time (a few seconds per sample) permits the analyses of large numbers of plants. This is important in screening programmes and to ensure statistical significance.
2. Samples can vary enormously and include leaves, micro-plants, tissue- or suspension cultures, suspensions of cells or chloroplasts, clones of algae on agar plates, etc.

3. The instrument that measures fluorescence is light-weight, portable and independent of external power sources for more than a working day.
4. Fluorescence data are digitised in real time and stored in the instrument's core memory.

United States of America (ARS/UC – Paul Gepts)

Evolutionary genomics of beans

Knowledge of evolutionary patterns and processes is essential to understand how organisms, in general, and plants, in particular, develop new traits, especially those of agronomic interest. Common bean is an excellent model in this respect (see Introduction), because of the extensive knowledge developed on the phylogeny of the genus and the genealogy of the species.

In this respect ARS/UC studies two main themes: (1) evolution of small multi-gene families involved in seed protein production; and (2) evolution of domestication traits. The former include the gene family coding for phaseolin, the major seed storage protein of common bean, and the APA family, i.e., the arcelin–phytohaemagglutinin–alpha-amylase inhibitor family that is involved in defence against animal predators, especially seed weevils. Domestication traits include those that distinguish various bean cultivars from one another. As examples, the determinacy gene controls

growth habit and is often found in domesticated bush beans, especially in snap-bean cultivars, where it assures both earliness and single-pass harvest of pods of more or less the same age. The pod-shattering gene is essential to wild beans to assure seed dissemination and reproduction of the plant. In domesticated beans, this is obviously a deleterious trait.

Genomics offers the potential to isolate the genes responsible for these traits and, in turn, improve them in superior cultivars. Some of the results to be expected from genomics activities in association with classical breeding are increased protein levels, resistance to seed-boring insects, reduced pod shattering, and improved plant type (Table 8). For the isolation of the phaseolin and APA gene families, both coded by a single, complex locus, we are developing four bacterial artificial chromosome (BAC) libraries. These are being constructed from genotypes that were carefully chosen to represent successive stages in the APA and phaseolin multi-gene families (see Figure 7). Genotype 1 is a *Phaseolus lunatus* cv. Henderson (lima bean) line that is representative of the legume family in that it only has the PHA (phytohaemagglutinin) component of APA. Its phaseolin is characterised by post-translational cleavage, which is unusual in *Phaseolus* species. Genotype 2 is *P. vulgaris* DGD 1962, which is representative of the presumed ancestor of *P. vulgaris* from Ecuador and northern Peru and therefore a key to the understanding the genetic diversity of *P. vulgaris*. Genotype 3 is *P. vulgaris* cv. BAT93, a multiple disease resistant genotype that is also one of the parents of the core mapping population of common bean (Freyre et al., 1998; Kami and Gepts, 2000). Genotype 4 is *P. vulgaris* G02771, a carrier of arcelin and strong resistance against seed weevils. Ordered groups of overlapping clones (contigs) each comprising about 180 kbp will be constructed around the APA locus and the organisation of APA genes determined. Sequencing of the APA locus in the four genotypes will then be initiated. Similar techniques will be used on the phaseolin locus (*Phs*) that encompasses some 190 kbp.

In addition, we will focus on the determinacy (*fin*) and pod string (*st*) loci. Unlike the seed protein loci, the genes for these loci have not yet been isolated, although candidate genes may be found amongst the ESTs of meristems and pods, respectively. An additional tool, which will have great repercussions in crop biodiversity, characterisation and utilisation, is linkage disequilibrium (LD) analysis. Traditionally, genes have been located on genetic maps by linkage analysis.

In a segregating population such as an F_2 , BC_1 , or RI population, correlation between the segregations of genes is generally interpreted as resulting from physical linkage on a DNA molecule (or chromosome). An advantage of this approach is that all individuals in these populations are genetically related because they stem from the same two parents. This approach therefore circumvents genetic drift and can lead to correlations among genes, regardless of whether they are linked or not. A disadvantage is the limited number of segregating generations during which effective recombination (i.e., between double heterozygotes) can take place. Thus, the placement of a gene is typically imprecise. This is especially true for genes that have small phenotypic effects and/or environmental regulation.

Linkage disequilibrium (LD) analysis is an alternative measure of association, which relies on existing populations of unrelated individuals rather than on segregating populations resulting from a cross. The use of genomics promises to instill a new life into this concept, principally as a way to locate genes on a linkage map, by allowing the development of markers that: (A) can be used to develop a fine map around the locus of interest; and (B) analyse the structure of genetic diversity. Indeed, one of the drawbacks is that LD can be caused by factors other than physical linkage, such as genetic drift, gene flow (admixture), and selection. Many of these disadvantages can be overcome if a large number of well-chosen molecular markers are used on a genome-wide basis. Most of the recent published studies on LD on a genome-wide analyses have been conducted in a limited number of species, including humans (Daly et al., 2001; Jeffreys et al., 2001), *Drosophila pseudoobscura* (Schaeffer et al., 2001), and *Zea mays* (Remington et al., 2001; Thornsberry et al., 2001). Irrespective of the inherent variability among loci, the lowest levels of LD were found in *D. pseudoobscura* and maize (about 1 kbp), followed by humans (several kbp). Towards these ends, the *fin* and *st* genes have been mapped on linkage groups 1 and 2, respectively (Koinange et al., 1996 – see Figure 7). RFLP markers have been or are being transformed into Sequence Tagged Sites (STS) to facilitate their use as PCR-based markers, with or without subsequent digestion with restriction enzymes. These markers will serve in preliminary experiments (on a genome-wide basis) to measure LD in common beans around loci of interest. Target loci will include not only the *fin* and *st* loci but also the *Phs* and APA loci to pinpoint the

specific areas that may be involved in e.g. the amount of protein produced.

USA (DMGCB/UC – Bob Haselkorn)

Acetyl CoA carboxylase in Phaseolus vulgaris

Acetyl CoA carboxylase (ACCCase) catalyses the first committed step in fatty acid biosynthesis, the addition of CO₂ to acetyl CoA to make malonyl CoA. This reaction occurs in two steps: the ATP-dependent carboxylation of biotin followed by the transfer of the carboxy group to acetyl CoA. In prokaryotes, this synthesis involves the activation of CO₂ by biotin carboxylase (BC, a homodimer) and addition of the CO₂ to biotin covalently linked to a lysine side-chain on the biotin carboxyl carrier protein (BCCP, a homodimer). Carboxytransferase, an α₂β₂ heterotetramer, then transfers the carboxy group from biotin to acetyl CoA. In most eukaryotes, all four domains of ACCCase are located on single, large polypeptides of at least 2600 amino acids. These function as dimers or higher order polymers. Many levels of phosphorylation as well as feedback using downstream metabolites control ACCCases.

In plants, fatty acids are synthesised in chloroplasts. The chloroplast ACCCase in grasses is a typical eukaryotic multi-domain ACCCase, whose transport into the chloroplast is facilitated by a transit peptide at the N-terminus. In dicotyledonous plants, however, the chloroplast ACCCase is like that of prokaryotes, comprised of four separate polypeptides. In the cases already studied (*Arabidopsis*, spinach, tobacco) one of these polypeptides, the beta subunit of the carboxytransferase, is encoded in chloroplast DNA while the other three are encoded in the nucleus. The situation in *P. vulgaris* is unknown.

We have studied the organisation, evolution and function of the ACCCase gene family in hexaploid wheat (Gornicki et al., 1993a,b; 1994). The cytoplasmic enzyme is encoded in a small gene family consisting essentially of two tandemly repeated genes on each of the ancestral chromosome sets (Podkowinski et al., 1996). These genes each contain 32 introns, are about 20 kb long, undergo alternative splicing, and have two promoters each yielding leaders with complex splicing and translational control sequences. A single gene on each ancestral chromosome set encodes the chloroplast enzyme (Gornicki et al., 1997). The chloroplast isozyme is similar to the cytoplasmic enzyme in size and organisation, differing principally by the inclusion of an N-terminal extension serving as a transit pep-

tide for transport into the chloroplast. In wheat, maize and rice, the cytoplasmic and chloroplast isozymes differ in sequence at many places, but one residue in particular, an ile/leu residue, determines sensitivity or resistance to herbicides of the aryloxyphenoxypropionate class (Joachimiak et al., 1997; Zagnitko et al., 2001). Monocotyledonous chloroplast isozymes are sensitive while those of the Dicotyledons, with their prokaryote-type of chloroplast ACCCase, are all resistant.

In green tissues of wheat, chloroplast ACCCase accounts for 95% of the total ACCCase mRNA and ACCCase activity. In roots, most of the ACCCase mRNA and activity are cytoplasmic. The malonyl CoA produced in chloroplasts is used for fatty acid synthesis. In the cytoplasm, malonyl CoA is required for malonylation reactions, synthesis of the nuclear envelope, and secondary metabolite synthesis, including flavonoids. In wheat, the levels of all classes of ACCCase mRNA are developmentally regulated. This has been studied using sectioned seedlings, measuring the RNA levels using Northern gels, RT-PCR, and promoter-GUS fusions in transient expression assays, both callus and intact embryos. Virtually nothing is known about ACCCase in beans. Based on experience with other plants such as soybean and various Brassicaceae, however, it should be possible to identify both cDNA and genomic clones of ACCCase genes in libraries of *Phaseolus* DNA. We expect to find genes encoding the multi-domain cytoplasmic ACCCase and the multi-component chloroplast enzyme. Sequencing these genes and cDNAs will provide the necessary background information for developmental studies of ACCCase gene expression including the response to nodulation and Nod-factors. As the complete pathway for fatty acid biosynthesis has been described in *Arabidopsis*, it should be possible to use *Arabidopsis* information to clone the *Phaseolus* counterparts. In this way, we expect to assemble a set of probes to follow expression, using limited micro-arrays, of the entire fatty acid pathway during nodulation of beans.

USA (EL/MSU – James Kelly)

Bean breeding is a multifaceted challenge requiring an optimum balance of the 'tried and true' traditional breeding approaches with the need to incorporate new methods that could improve efficiency or permit the exploitation of genetic variability for traits of economic value. Traditional breeding methods need to be varied depending on germ-plasm, objectives, traits,

and resources and should be periodically evaluated or changed, as no single method is suitable for all situations (Kelly et al., 1998). Finding ways to incorporate the new biotechnology tools and 'traits' will be challenging as the technologies demand increased costs and facilities associated with an increased level of uncertainty regarding outcome and usefulness (Kelly and Miklas, 1998). The potential divisiveness of intellectual property considerations, and consumer concerns currently cloud the future of biotechnology, plant transformation and the potential impact of genomics in bean breeding in the XXI century. The bean breeding and genetics programme at Michigan State University utilizes an integrated approach to bean improvement that employs methodologies that identify and exploit novel genetic variability in the wild species; that incorporate marker technologies to enhance quality traits as well as protect against biotic stresses; and that integrate genetic maps to assist in gene discovery using map based cloning and plant transformation systems to achieve specific objectives. A gene that imparts resistance to a major disease pathogen of common bean is a current target.

We have discovered a unique anthracnose resistance gene, *Co-4²* that conditions resistance to 97% of races of *Colletotrichum lindemuthianum* present in North and South America (Balardin and Kelly, 1998). Tests indicate that the *Co-4* locus is multi-allelic and encodes a protein kinase (Melotto and Kelly, 2001). Understanding the molecular organisation of resistance genes will shed light on their evolution and facilitate studies on plant-pathogen interactions. We plan to use a map-based cloning strategy to isolate the *Co-4* locus in the black bean genotype SEL 1308. Map-based cloning includes: (1) saturating the region with molecular markers and identifying tightly linked flanking markers; (2) chromosome walking to the gene of interest using a genomic library; and (3) confirming the function of the isolated gene. Many disease resistance genes have been successfully cloned using this approach. The experimental procedure will consist of:

1. Saturating the *Co-4²* gene locus with tightly linked markers. To facilitate the cloning of the *Co-4²* gene we need to further saturate that region with additional markers. To date, we have identified four SCAR markers tightly linked to the *Co-4²* gene and with the recent mapping of *Co-4²* to linkage group B8 on the core *Phaseolus* map (see Figure 4), we have access to other genetic linkage maps providing >20 tentative markers adjacent to this locus. In addition, we are developing SSR and AFLP markers on B8.
2. Constructing a BAC library of the genotype SEL 1308. One essential requirement for molecular cloning of genes is the generation a clone library with large DNA inserts. The most commonly used system for constructing a large insert genomic library is the bacterial artificial chromosome (BAC) system. A BAC library of the *Co-4²* locus containing genotype SEL 1308 will be constructed (Vanhouten and MacKenzie, 1999).
3. Selecting BAC clones that contain the *Co-4²* locus. A PCR based strategy will be used to select BAC clones that contain the *Co-4²* locus. BACs will be separated into pools and markers linked to the gene will be used to select pools that contain the locus. Pools that are positive will be screened for individual BACs that contain the gene by PCR.
4. Chromosome walking to sequence the *Co-4²* locus. Chromosome walking to sequence the region will be performed using the Universal Genome Walker™ Kit (Clontech). The selected clones will be digested and a Genomewalker adaptor will be ligated to the blunt ends. PCR amplification using primers designed for the adaptor and a marker linked to the gene will be carried out. Hopefully, the result will be a single PCR product that has a known 5' end sequence and extends into the unknown adjacent genomic DNA. This product will be cloned and sequenced. Sequences are aligned in a contig based on overlapping regions.
5. Identification of promoters, ORFs, splice-sites, etc. Using the sequence information, candidate genes will be tested for function and race specificity using a plant transformation biolistic method developed by Aragão et al. (1998, 2002) for use in common bean.

USA (NDSU/F – Phil McClean)

Beans are an important international source of protein as reflected by the fact that the dry bean export market alone (exclusive of canning beans) has a value to the US economy of \$1.8 billion (<http://www.ers.usda.gov/briefing/drybeans/>). The cash value of the crop at the farm gate is \$1 billion. Many agronomic factors contribute to their importance, particularly because they provide a valuable crop to the farmer even though production has been pushed to marginal quality soils by other crops. Farm-

ers utilize these marginal soils from sea level to as high as 3000 m. Furthermore, although common bean is a tropical legume, its cultivated range extends from the tropics to 45° latitude. This agronomic plasticity is a direct result of the genetic diversity of the species. As an example, the United States Department of Agriculture (USDA) recognises ten common bean market classes, each distinguished by their size, seed coat colour and pattern. Although the species is diverse, breeding efforts have only made marginal improvements in yield, especially in comparison with other crops such as cereals. An important objective for the *Phaseolus* research community in the new millennium is to describe research approaches that best characterise the important agronomic diversity necessary to improve this crop.

Genomics, especially ESTs

ESTs are important in developing new classes of molecular markers needed for applied genetics research, and will lead to the discovery of simple sequence repeat (SSR) variation in common beans. This information is necessary to develop user-friendly SSR markers that can be applied, for example, in crop improvement programmes. To do this, cDNA libraries will be created from two different genotypes for each tissue source. Comparable genes identified in the two parental genotypes will be scanned for SSR variation. The use of BAT93 and Jalo EEP558, two genotypes used extensively for mapping purposes, will allow us to place these newly discovered ESTs on a common linkage map. The map can be used for both basic and applied genetics research. Steps in this project will include: (1) cDNA library development; (2) high throughput sequencing; (3) search for novel genes; (4) SSR discovery; (5) data analysis (see also UW/M – Eric Triplett).

USA (MSU/B – Tim McDermott and Dan Bergey)

Over the last decade, the McDermott laboratory has focused on phosphorous (P) metabolism in *Rhizobium tropici*-bean symbiosis (Al-Niemi et al., 1997, 1998; Botero et al. 2000). Based on this work we suggest that the bean plant provides its bacteroids with very low levels of inorganic P. We also know from labeling work (Al-Niemmi et al., 1998), and P fertiliser placement experiments (unpublished data) that bean nodules are a strong sink for root-acquired P, and that proper nodule P nutrition appears to be critical to the overall performance of the symbiosis (unpub-

lished data). *R. tropici pho* mutants can be effective tools for dissecting host-bacteroid P relations. We plan to use these mutants in experiments to investigate host nodule gene expression in response to experimentally manipulated bacteroid P acquisition and metabolic activities. We will pair these mutants and their wild-type parental strain with common bean genotypes (two cultivars) that differ in P-use efficiency and are available from our collaborations with Dr. J.-J. Drevon.

The experimental approach that we will use in the first instance will be based on micro-arrays. Each of the two bean P-use efficiency cultivars will be grown in combination with the wild-type *R. tropici* strain CIAT899. Nodule-specific mRNA from each symbiosis will be isolated using oligo-dT affinity columns, and cDNA libraries prepared. For hybridisation experiments, mRNA from appropriate pair-wise combinations between the bacterial *pho* mutants and the bean P-use cultivars will be isolated, and labeled by reverse transcription in the presence of the fluorescent dyes Cy3-dUTP, or Cy5-dUTP. Differentially labeled mRNA populations will be co-hybridised to each respective array, and the arrays will be scanned to assess Cy3/Cy5 ratios from each spot. Differentially expressed (both up- and down-regulated) sequences will be identified by relative differences in fluorescent color emitted. Replicate arrays will be made, allowing for statistical analysis (ANOVA) on each candidate differentially expressed gene. Confirmation of candidate differentially expressed genes will be made using Northern blot analysis. We will also prepare labelled cDNAs from leaf and root tissues from these same pairings, but will provide these to other interested labs within the collaborative group for examination of system-wide effects of altered nodule P metabolism on general host metabolism and gene expression.

As development of the EST database progresses, comprehensive and relatively rapid analysis of changes in host gene expression during nodulation will become increasingly feasible using serial analysis of gene expression (SAGE). We have practical experience making SAGE libraries and using SAGE-specific analytical software.

USA (UAT – Richard Musser)

Functional genomic analyses of bean defense responses to insect attack

Herbivory triggers plant responses that are qualitatively and quantitatively different from artificial

wounding or mechanical damage. Recently, oral secretions from insects have been shown to elicit profound effects on the responses of plants. Oral secretions of herbivorous insects can stimulate anti-herbivore defences, plant growth, and phytopathogen resistance. The elicitors β -glucosidase and volicitin stimulate anti-herbivore defences. However, we found that glucose oxidase, a salivary component of *Helicoverpa zea* can suppress induced anti-herbivore defences in tobacco plants. Glucose oxidase also appears to be an elicitor of plant pathogen defences. Ribonuclease activity is found, at high levels, in Mexican bean beetle regurgitant. We found that *Phaseolus vulgaris* cv. Pinto bean leaves that were wounded and treated with RNase had increased virus resistance. This evidence suggests that RNase activity in the regurgitant of the Mexican bean beetle functions as an elicitor of plant pathogen defences.

The specific objectives of our proposal are to:

1. Identify salivary factors responsible for plant defence responses.
2. Determine how insect herbivory alters plant defence genes via DNA microarray analysis.
3. Correlate plant protein expression with gene expression in response to herbivory.
4. Correlate metabolic data with gene expression in response to herbivory.
5. Correlate whole plant effects with susceptibility to herbivory, and to disease.
6. Compare gene expression in plants with insect age, and location of herbivory.
7. Compare gene expression of plants with tolerance to herbivores.
8. Examine the possible relationships between gene for gene interaction between herbivores and plants.

We will compare the genome wide response to herbivory by insects with different feeding modes and salivary components that are thought either to stimulate or suppress plant defences on two economically important host plants, maize and bean. In addition, we will utilise *Arabidopsis thaliana* as a comparative model genomic system. As insects we will use two generalist herbivores, *Helicoverpa zea* (Corn Earworm/Tomato Fruitworm) that feeds on maize, beans, and *A. thaliana* as well as Whiteflies which feed on beans, and *Arabidopsis*. Gene expression of plants suffering from herbivory will be compared to those of plants that have been fed upon by insect specialist herbivores such as *Diatraea grandiosella* (Southwestern Corn Borer), *Epilachna varivestis* Mulsant (Mexican Bean Beetle), *Pieris rapae* (Lesser Cabbage

Butterfly) which feeds on maize, beans, and *Arabidopsis*, respectively. We expect that the patterns of gene expression in the host-plants will depend on the specific herbivore and their salivary elicitor.

Hopefully, these experiments will provide a genome wide indication of how plants respond to salivary elicitors and insect herbivory. Knowledge of how a plant detects and responds to herbivory is severely limited especially in comparison to our understanding of how a plant detects and responds to plant pathogens.

USA (UN/L – Sally Mackenzie)

Genomics and transcriptomics

We have constructed a BAC library of total genomic DNA of the bean cultivar Sprite (Vanhouten and Mackenzie, 1999). Sequencing of the ends of individual BACs will be initiated so that a complete physical map of the bean genome can be developed. BAC contigs will be anchored to molecular markers from beans, soybeans, *Medicago* spp. and *Vigna unguiculata* (long-beans, cowpeas) for comparative genome analysis. In addition, mRNA will be isolated from developing ovules and roots of *P. vulgaris* cv. Sprite and these ESTs contributed to the Phaseomics database.

USA (MU/M – Dale Noel)

Determinants of infection and bean nodule development

Insufficient nitrogen fixation by beans in agriculture often derives from poor infection and nodule development. At Marquette University we study bacterial factors that affect infection of the plant after Nod-factors trigger nodule initiation. These studies have shown that progress of the infection thread determines whether later events in nodule development occur. Unless the infection thread crosses five cell layers of the developing nodule, the primordium develops into a pseudo-nodule that resembles a lateral root rather than a true nodule (Newman et al., 1992; Noel, unpublished). If however infection stops after crossing ten cell layers, development proceeds to a later endpoint that has true nodule anatomy with a central zone of two types of cells; a normal peripheral vasculature, and other tissue layers characteristic of a true nodule, even though bacteroids are absent (Newman et al., 1992; Noel, unpublished).

These generalisations apply to determinate nodule development, at least as it occurs in the tribe

Phaseoleae (that includes soybeans as well as common beans). Other 'model' legumes (*L. japonicus* and *M. truncatula*) are not suited to studying this type of development. Nodulation of *M. truncatula* is indeterminate; while that of *L. japonicus* is determinate but deviates in many important details from that of the *Phaseoleae*. Aside from its agronomic importance, *P. vulgaris* is an excellent biological model for studying nodule development. It nodulates prolifically with appropriate rhizobial strains, nodule initiation is synchronous (a burst of 50 or more nodules in a cluster appear within about 1 day of one another), and nodules are large, thereby facilitating biochemical analyses. The main limitation to full utilisation of this system to understand determinate nodule development is the lack of tools for genomic and transcriptomic analysis of this plant.

We use purine auxotrophs that are completely blocked in infection unless the purine intermediate AICA riboside is supplied (Newman et al., 1992) to study nodule development in beans. Here we will construct cDNA libraries from nodules in which infection stops after penetrating ten cell layers and will use several approaches to eliminate those sequences that are expressed in nodule primordia in which infection stops before penetrating five cell layers. The existence of a reasonably complete genome sequence or a more complete bank of ESTs would obviously greatly accelerate this effort.

Another bacterial determinant that is critical for infection of beans and many other legumes is the polysaccharide portion of the surface lipopolysaccharide (LPS). It is a dynamic structure that is altered by the bacteria in response to conditions that exist in the rhizosphere and inside the nodule. In the *R. etli*-bean symbiosis, certain structural features of this polysaccharide appear to be required for normal infection (Noel et al., 2000). One possible explanation for this structural specificity is that the LPS acts as a ligand for receptors, which when bound to LPS trigger responses that are required for infection thread development. We are looking for a protein receptor that binds the wild-type LPS but less well to mutant LPSs that cause slower infection. Again, the availability of genome sequences and EST databases would be of great help. N-terminal sequencing would immediately identify candidate gene(s) for putative receptors and we could immediately design tests of specific expression of members of the gene family. With micro-arrays, we could look for expression of genes uniquely induced by appropriate LPS structures

or for ESTs induced early in infection by the wild-type bacteria but not by mutants defective in LPS.

USA (UW/M – Eric Triplett)

Genomic Interspecies Micro-array Hybridisation (GIMH) will be performed in collaboration with NDSU/F – Phil McClean (see above) to rapidly identify genes in *P. vulgaris* (see Dong et al., 2001). To do this, micro-arrays will be spotted with a unique set of soybean ESTs. Then, genomic DNA of both beans and soybeans that has been digested with restriction enzymes and fluorescently labelled will be hybridised to the arrays. This will be followed by experiments where digested, fluorescently labelled genomic DNA from soybeans and *Medicago truncatula* will be hybridised to the arrays. This will identify genes that are expressed in *P. vulgaris*, and provide a quantitative relationship assessment of the relationships between beans, soybeans and *M. truncatula*. We expect that beans and soybeans will have more common homologues than in comparison with *M. truncatula*, and that these will be enriched in determinants of grain yield. Based on the results of these experiments we will construct new micro-arrays using selected soybean ESTs. Gene expression in all tissues will be studied this way. Each array experiment will be replicated at least six times and be performed before ESTs from *P. vulgaris* become widely available.

Common names of *Phaseolus* spp.

- *P. acutifolius* A. Gray=teparty bean.
- *P. coccineus* L.=scarlet runner bean.
- *P. lunatus* L.=Burma or butter or Lima bean.
- *P. vulgaris* L.=baked or canellini or common or dwarf or flageolet or frijoles or French or kidney or navy or pinto or snap or string or wax or haricot or Nuñas bean.

Acknowledgements

We wish to thank Dora Gerber for her unstinting help with all aspects of this work. We gratefully acknowledge the financial support of the *IIIe Cycle Romand en Sciences Biologiques* (C. Penel), *le Décanat of the Faculté des Sciences* (J. Weber), as well as *la Section de Biologie* (P. Spierer) of l'Université de Genève and Applied Biosystems Rotkreuz Branch

(A.L. Monsutti), during the second Phaseomics conference (Geneva, May 16 to 19, 2002). Research in LBMPs is supported by the Fonds National Suisse de la Recherche Scientifique (Project 31-63893.00).

References

- Aguilar O M, López M V and Riccillo P M 2001 The diversity of rhizobia nodulating beans in Northwest of Argentina as a source of more efficient inoculant strains. *J. Biotechnol.* 91, 181–188.
- Aguilar O M, López M V, Riccillo P M, González R A, Marcela Pagano, Grasso D H, Puhler A and Favelukes G 1998 Predominance of the 16S rDNA gene allele of *R. etli* in the indigenous population of rhizobia found associated with wild beans from the Southern Andes in Argentina. *Appl. Environ. Microbiol.* 64, 3520–3524.
- Aharoni A, Keizer L C P, Bouwmeester H J, Sun Z K, Alvarez-Huerta M, Verhoeven H A, Blaas J, van Houwelingen A M M L, De Vos R C H, van der Voet H, Jansen R C, Guis M, Mol J, Davis R W, Schena M, van Tunen A J and O'Connell A P 2000 Identification of the SAAT gene involved in strawberry flavor biogenesis by using DNA micro-arrays. *Plant Cell* 12, 647–661.
- Al-Niemi T S, Kahn M L and McDermott T R 1997 P metabolism in the *Rhizobium tropici*-bean symbiosis. *Plant Physiol.* 113, 1233–1242.
- Al-Niemi T S, Kahn M L and McDermott T R 1998 Bean nodule phosphorus uptake. *Plant Soil* 198, 71–78.
- Alstrom S 1995 Evidence of disease resistance induced by rhizosphere pseudomonad against *Pseudomonas syringae* pv. *Phaseolica*. *J. Gen. Appl. Microbiol.* 41, 315–325.
- Altamirano-Hernández J 2000 Acumulación de trehalosa en leguminosas de una selva tropical estacional. M.Sc. Thesis. UMSNH, Morelia, Michoacán, México.
- Antoun H and Klopper J W 2001 Plant Growth Promoting Rhizobacteria (PGPR). *Encyclopedia of Genetics*. Academic Press.
- Antoun H, Beauchamp C J, Goussard N, Chabot R and Lalonde R 1998 Potential of *Rhizobium* and *Bradyrhizobium* species as plant growth promoting rhizobacteria on non-legumes: effect on radishes (*Raphanus sativus* L.). *Plant Soil* 204, 57–67.
- Antoun H, Bordeleau L M and Lachance R A 1979 Rendement de la luzerne (cultivar Saranac) inoculée avec une souche très efficace de *Rhizobium meliloti* en présence d'autres espèces de *Rhizobium*. *Can. J. Plant Sci.* 59, 521–523.
- Arabidopsis Genome Initiative 2000 Analysis of the genome sequence of the flowering plant *Arabidopsis thaliana*. *Nature* 408, 796–815.
- Aragão F, Barros L, Brasileiro A, Ribeiro S, Smith F, Sanford J, Faria J and Rech E 1996 Inheritance of foreign genes in transgenic bean (*Phaseolus vulgaris* L.) co-transformed via particle bombardment. *Theor. Appl. Genet* 93, 142–150.
- Aragão F, Ribeiro S, Barros L, Brasileiro A, Maxwell D, Rech E and Faria J 1998 Transgenic beans (*Phaseolus vulgaris* L.) engineered to express viral antisense RNAs show delayed and attenuated symptoms to bean golden mosaic geminivirus. *Mol. Breed.* 4, 491–499.
- Aragão F J L, Ribeiro S G, Barros L MG, Brasileiro A C M, Maxwell D P, Rech E L and Faria J C 1998 Transgenic beans (*Phaseolus vulgaris* L.) engineered to express viral antisense RNAs show delayed and attenuated symptoms to bean golden mosaic geminivirus. *Mol. Breed.* 4, 491–499.
- Aragão F J L, Vianna G R, Albino M M C and Rech E L 2002 Transgenic dry bean tolerant to the herbicide glufosinate ammonium. *Crop Sci.* 42, 1298–1302.
- Ariyaratne H M, Coyne D P, Jung G, Skroch P W, Vidaver J R, Steadman A K, Miklas P N, Bassett M J 1999 Molecular mapping of disease resistance genes for halo blight, common bacterial blight, bean common mosaic virus in a segregating population of common bean. *J. Amer. Soc. Hort. Sci.* 124, 654–662.
- Atkins C A 1991 Ammonia assimilation and export of nitrogen from the legume nodule. *In* *Biology and Biochemistry of Nitrogen Fixation*. Eds. M J Dilworth, A R Glenn. pp. 293–319. Elsevier, Amsterdam.
- Atkins C A, Sanford P J, Storer P J, Pate J S 1988 Inhibition of nodule functioning in cowpea by a xanthine oxidoreductase inhibitor, allopurinol. *Plant Physiol.* 88, 1229–1234.
- Atkins C A and Smith P M C 2000 Ureide synthesis in legume nodules. *In* *Prokaryotic Nitrogen Fixation. A Model System for the Analysis of a Biological Process*. Ed. E J Triplett. pp. 559–587. Horizon Scientific Press, Wymondham, Norfolk, UK.
- Atkins C A, Smith P M C and Storer P J 1997 Re-examination of the intracellular localization of de novo purine synthesis in cowpea nodules. *Plant Physiol.* 113, 127–135.
- Bachem C W, Horvath B, Trindade L, Claassens M, Davelaar E, Jordi W and Visser R G 2001 A potato tuber-expressed mRNA with homology to steroid dehydrogenases affects gibberellin levels and plant development. *Plant J.* 25, 595–604.
- Bachem C W, Oomen R J F and Visser R G 1998 Transcript imaging with cDNA-AFLP: a step-by step protocol. *Plant Mol. Biol. Rep.* 16, 157–173.
- Bachem C W, Oomen R J F, Kuyt S, Horvath B M, Claassens M M, Vreugdenhil D and Visser R G 2000 Antisense suppression of potato alpha-SNAP homologue leads alterations in cellular development and assimilate distribution. *Plant Mol. Biol.* 43, 473–482.
- Bachem C W, van der Hoeven R, de Bruijn S, Vreugdenhil D, Zabeau M and Visser R 1996 Visualisation of differential gene expression using a novel method of RNA fingerprinting based on AFLP analysis of gene expression during potato tuber development. *Plant J.* 9, 745–753.
- Balardin R S and J D Kelly 1998 Interaction between in *Colletotrichum lindemuthianum* races and gene pool diversity in *Phaseolus vulgaris*. *J. Amer. Soc. Hort. Sci.* 123, 1038–1047.
- Baldet P, Alban C and Douce R 1997 Biotin synthesis in higher plants: purification of *bioB* gene product equivalent from *Arabidopsis thaliana* overexpressed in *Escherichia coli* and its subcellular location in pea leaf cells. *FEBS Lett.* 419, 206–210.
- Baldet P, Alban C, Axiotis S and Douce R 1993a Localization of free and bound biotin in cells from green pea leaves. *Arch. Biochem. Biophys.* 303, 67–73.
- Baldet P, Gerbling H, Axiotis S, Douce R 1993b Biotin biosynthesis in higher plant cells: identification of intermediates. *Eur. J. Biochem.* 217, 479–485.
- Baldwin I T, Halitschke R, Kessler A and Schittko U 2001 Merging molecular and ecological approaches in plant–insect interactions. *Curr. Opin. Plant Biol.* 4, 351–358.
- Bassett M J, Brady L, McClean P E 1999b A new allele, *t^{cf}*, at the *T* locus for partly colored seedcoats in common bean. *J. Amer. Soc. Hort. Sci.* 124, 654–662.
- Bassett M J and McClean P E 2000 A brief review of the genetics of partly colored seed coats in common bean. *Annu. Rep. Bean Improv. Coop.* 43, 99–100.
- Bassett M J, Shearon C and McClean P E 1999a Allelism between the hilum ring locus *D* and the partly colored seedcoat locus *Z* in common bean *J. Amer. Soc. Hort. Sci.* 124, 649–653.

- Bassett M J, Hartel K and McClean P E 2000 Inheritance of the Anasazi pattern of partly colored seedcoats in common bean. *J. Amer. Soc. Hort. Sci.* 125, 340–343.
- Batista S, Catalán A I, Hernández-Lucas I, Martínez-Romero E, Aguilar O M and Martínez-Drets G 2001 Identification of a system that allows a *Rhizobium tropici* *dctA* mutant to grow on succinate, but not on other C4-dicarboxylates. *Can. J. Microbiol.* 47, 1–10.
- Baudoin J P 2001 Contribution des ressources phylogénétiques à la sélection variétale de légumineuses alimentaires tropicales. *Biotechnol. Agron. Soc. Environ.* 5(4), 221–230.
- Baudoin J P, Camarena F and Lobo M 1995 Amélioration de quatre espèces de légumineuses alimentaires tropicales *Phaseolus vulgaris*, *P. coccineus*, *P. polyanthus* et *P. lunatus*. Sélection intra- et interspécifique. In *Quel Avenir Pour l'amélioration des Plantes? Quatrième Journées Scientifiques du Réseau Biotechnologie Végétale de l'UREF*, Namur, 18–21 Octobre 1993. Ed. par J Dubois, Y Demarj, AUPELF-UREF. pp. 31–49. John Libbey Eurotext, Paris.
- Baudoin J P, Camarena F, Lobo M, Mergeai G 2001 Breeding *Phaseolus* for intercrop combinations in Andean highlands. In *Broadening the Genetic Basis of the Crop*. Ed. H D Cooper, C Spillane, T Hodgkin. pp. 373–384. CAB International, Wallingford, UK.
- Baudoin J P, Fofana B, du Jardin P and Vekemans X 1998 Diversity and genetic organization of the genus *Phaseolus*. Analysis of the global and chloroplastic genome. In *International Symposium on Breeding of Protein and Oil Crops*. pp. 75–76. EUCARPIA, Fundación Pedro Barrié De La Maza.
- Beaver J S and Kelly J D 1994 Comparison of selection methods for dry bean populations derived from crosses between gene pools. *Crop Sci.* 34, 34–37.
- Beebe S, Skroch P W, Tohme J, Duque M C, Pedraza F and Nienhuis J 2000 Structure of genetic diversity among common bean landraces of Middle American origin based on correspondence analysis of RAPD. *Crop. Sci.* 40, 264–273.
- Beebe S, Cardona C, Diaz O, Rodriguez F, Mancía E, Ajquejay S 1993 Development of common bean (*Phaseolus vulgaris* L.) lines resistant to the bean pod weevil, *Apion godmani* Wagner, in Central America. *Euphytica* 69, 1–2, 83–88.
- Bennett M D and Leitch I J 1995 Nuclear DNA amounts in angiosperms. *Annals. Botany* 76, 113–176.
- Bennett M D and Leitch I J 2001 Plant DNA C-values Database (release 1.0, Sept. 2001). <http://www.rbgekew.org.uk/cvalues/homepage.html>.
- Bennett M D, Bhandol P and Leitch I J 2000 Nuclear DNA amounts in angiosperms and their modern uses – 807 new estimates. *Ann. Bot.* 86, 859–90.
- Bennetzen J and Freeling M 1997 The unified grass genome: synergy in synteny. *Genome Res.* 7, 301–306.
- Billington T, Pharmawati M and Gehring C A 1997 Isolation and immunoaffinity purification of biologically active plant natriuretic peptide. *Biochem. Biophys. Res. Comm.* 235, 722–725.
- Blaume B, Nürnberger T, Nass N and Scheel D 2000 Receptor-mediated increase in cytoplasmic free calcium required for activation of pathogen defense in Parsley. *Plant Cell* 12, 1425–1440.
- Bliss F A and Brown J W S 1983 Breeding common bean for improved quantity and quality of seed protein. *Plant Breed. Rev.* 1, 59–102.
- Botero L M, Al-Niemi T S and McDermott T R 2000 Characterization of two inducible phosphate transport systems in *Rhizobium tropici*. *Appl. Environ. Microbiol.* 66, 15–22.
- Boukli N M, Hochstrasser D F and Broughton W J 2002 Identification of a Nod-factor induced ATPase from *Vigna unguiculata* roots by proteomics of phosphorylated proteins. *Mol. Plant-Microbe Interact.*, in preparation.
- Boutin S, Young N, Olson T, Yu Z, Shoemaker R and Vallejos C 1995 Genome conservation among three legume genera detected with DNA markers. *Genetics* 38, 928–937.
- Brady L, Bassett M J and McClean P E 1998 Molecular mapping in common bean: RAPD markers for *T* and *Z*, two genes controlling partly colored seed coat patterns in common bean. *Crop Sci.* 38, 1073–1075.
- Bressani R 1983 Research needs to upgrade the nutritional quality of common beans (*Phaseolus vulgaris*). *Qual. Pl. Plant Foods Human Nutr.* 32, 101–110.
- Breyne P and Zabeau M 2001 Genome-wide expression analysis of plant cell cycle modulated genes. *Curr. Opin. Plant Biol.* 4, 136–142.
- Broughton W J, Heycke N, Meyer Z A H and Pankhurst C E 1984 Plasmid-linked *nif* and '*nod*' genes in fast growing rhizobia that nodulate *Glycine max*, *Psophocarpus tetragonolobus* and *Vigna unguiculata*. *Proc. Natl. Acad. Sci. USA* 81, 3093–3097.
- Broughton W J, Jabbouri S and Perret X 2000 Keys to symbiotic harmony. *J. Bacteriol.* 182, 5641–5652.
- Broughton W J, Wong C-H, Lewin A, Samrey U, Myint H, Meyer z A H, Dowling D N and Simon R 1986 Identification of *Rhizobium* plasmid sequences involved in recognition of *Psophocarpus*, *Vigna* and other legumes. *J. Cell Biol.* 102, 1173–1182.
- Bueno J M, Cardona C and Quintero C M 1999 Comparison between two improvement methods to develop multiple insect resistance in common bean (*Phaseolus vulgaris* L.). *Revista Colombiana de Entomología* 25, 73–78.
- Burdman S, Jurkevitch E and Okon Y 2000 Recent advances in the use of plant growth promoting rhizobacteria (PGPR) in agriculture. In *Microbial Interactions in Agriculture and Forestry*, Vol II. Eds. N S Subba Rao and Y R Dommergues. pp. 229–250. Science Publishers, Inc. USA.
- Buttery B R, Park S J and van Berkum P 1997 Effects of common bean (*Phaseolus vulgaris* L.) cultivar and *Rhizobium* strain on plant growth, seed yield and nitrogen content. *Can. J. Plant Sci.* 77, 347–351.
- Camas A, Cárdenas L, Quinto C and Lara M 2002 Expression of different calmodulin genes in bean tissues and during the symbiotic process. *Mol. Plant-Microbe Interact.* 15, 428–436.
- Campalans A and Pages M 2001 Identification of differentially expressed genes by the cDNA-AF technique during dehydration of almond (*Prunus amygdalus*). *Tree Physiol.* 21, 633–643.
- Campion B, Ranalli S, Bollini R and Allavena A 1998 Bean. Italian contribution to plant genetics and breeding. Eds. G T Scarascia Mugnozza and M A Pagnotta, XV Congress of the European Association for Research on Plant Breeding EUCARPIA 21–25 September 1998 and XLII Congress of the SIGA 25–26 September 1998. pp. 371–377. Viterbo, Italy.
- Cárdenas L, Feijó J A, Kunkel J G, Sánchez F, Holdaway-Clarke T, Hepler P and Quinto C 1999 *Rhizobium* Nod factors induce increases in intracellular free calcium and extracellular calcium influxes in bean root hairs. *Plant J.* 19, 347–352.
- Cárdenas L, Vidali L, Domínguez J, Pérez H, Sánchez F, Hepler P K and Quinto C 1998 Rearrangements of actin microfilaments in plant root hairs responding to *Rhizobium etli* nodulation signals. *Plant Physiol.* 116, 871–877.
- Cárdenas L, Domínguez J, Quinto C, López-Lara I M, Lugtenberg B J J, Spaink H P, Rademaker G J, Haverkamp J and Thomas-Oates J 1995 Isolation, chemical structures and biological activity of the thr lipo-chitin oligosaccharide nodulation signals from *Rhizobium etli*. *Plant Mol. Biol.* 29, 453–464.

- Cárdenas L, Holdaway-Clarke T L, Sánchez F, Quinto C, Feijó J A, Kunkiel J G and Hepler P K 2000 Ion changes in legume root hairs responding to Nod factors. *Plant Physiol.* 123, 443–451.
- Carozzi N B and Koziel M G (Eds) 1997 *Advances in Insect Control: The Role of Transgenic Plants*. Taylor and Francis Inc., New York, UK.
- Cha T S and Shah F H 2001 Characterization of three isoforms for glutelins in oil palm kernel. *Plant Sci.* 160, 913–923.
- Chichkova S, Arellano J, Vance C P and Hernández G 2001 Transgenic tobacco plants that overexpress alfalfa NADH-glutamyl synthase have higher carbon and nitrogen content. *J. Exp. Bot.* 52, 2079–2087.
- Colmenero-Flores J M, Campos F, Garcíarrubio A and Covarrubias A A 1997 Characterization of *Phaseolus vulgaris* cDNA clones responsive to water deficit: identification of a novel late embryogenesis abundant protein. *Plant Mol Biol* 35: 393–405.
- Colmenero-Flores J M, Moreno L P, Smith C E and Covarrubias A A 1999 *Pvlea-18*, a member of a new LEA protein family: expression, protein accumulation, and immunolocalization during stress and development. *Plant Physiol.* 120: 93–103.
- Coulibaly S 1999 *PCR-derived analysis of genetic diversity and relationships within the Phaseolus vulgaris L. complex and in Vigna unguiculata L.* PhD, University of California, Davis.
- Cronan J E 1989 The *E. coli bio* operon: transcriptional repression by an essential protein modification enzyme. *Cell* 58, 427–429.
- Daly M J, Rioux J D, Schaffner S E, Hudson T J and Lander E S 2001 High-resolution haplotype structure in the human genome. *Nature Genet.* 29, 229–232.
- Daniels R, De Vos D E, Desair J, Raedschelders G, Luyten E, Rosemeyer V, Verreth C, Schoeters E, Vanderleyden J and Michiels J 2002 The *cin* quorum-sensing locus of *Rhizobium etli* CNPAF512 affects growth and symbiotic nitrogen fixation. *J. Biol. Chem.* 277, 426–430.
- Dantán-González E, Rosenstein Y, Quinto C and Sánchez F 2001 Actin monoubiquitylation is induced in plants in response to pathogens and symbionts. *Mol. Plant-Microbe Interact.* 14, 1267–1273.
- Dar G H, Zargar M Y and Beigh G M 1997 Biocontrol of *Fusarium* root rot in the common bean (*Phaseolus vulgaris* L.) by using symbiotic *Glomus mosseae* and *Rhizobium leguminosarum*. *Microb. Ecol.* 34, 74–80.
- Dávila G, Brom S, Collado-Vides J, Hernández G, Mora J, Palacios R and Romero D 2000 Genomics of *Rhizobium etli*. In *Prokaryotic Nitrogen Fixation: A Model System for Analysis of a Biological Process*. Ed. E W Triplett. Horizon Scientific Press, Wymondham, UK. 671–678.
- De Barro P J 1995 *Bemisia tabaci* biotype B: a review of its biology, distribution and control. Technical paper no. 36. CSIRO Australia, Canberra.
- De Clercq J, Zambre M, Van Montagu M, Dillen W and Angenon G 2002 An optimized *Agrobacterium*-mediated transformation procedure for *Phaseolus acutifolius* A. Gray. *Plant Cell Reports*. 21: 333–340.
- De Lorenzo G, D'Ovidio R and Cervonne F 2001 The role of polygalacturonase-inhibiting proteins (PGIPs) in defence against pathogenic fungi. *Annu. Rev. Phytopathol.* 39, 313–335.
- De Ron A M, Santalla M, Barcala N, Rodiño A P, Casquero P A and Menéndez M C 1997 Beans (*Phaseolus* spp.) collection at the Misión Biológica de Galicia – CSIC in Spain. *Plant Genetic Resources Newsletter* 112, 100.
- De Ron A M, Rodiño A P, Menéndez-Sevillano M C, Santalla M, Barcala N and Montero I 1999 Variation in wild and primitive Andean bean varieties under European conditions. *Ann. Rep. Bean Improvement Cooperative* 42, 95–96.
- Debouck D 1991 Systematics and morphology. In *Common Beans: Research for Crop Improvement*. Eds. A van Schoonhoven and O Voysest. pp. 55–118. CAB International, Wallingford.
- Debouck D G 1999 Diversity in *Phaseolus* species in relation to the common bean. In *Common Bean Improvement in the 21st Century*. Ed. S R Singh. pp. 25–52. Kluwer Academic Publisher, Dordrecht.
- Debouck D G 2000 Biodiversity, ecology and genetic resources of *Phaseolus* beans – Seven answered and unanswered questions. In *The Seventh MAFF International Workshop on Genetic Resources*. Part. 1. Wild Legumes. pp. 95–123. Tsukuba, Ibaraki, Japan-National Institute of Agrobiological Resources.
- Delgado Salinas A, Bruneau A and Doyle J J 1993 Chloroplast phylogenetic studies in New World Phaseolinae (Leguminosae: Papilionoideae: Phaseoleae). *Syst. Bot.* 18, 6–17.
- Delgado-Salinas A, Turley T, Richman A and Lavin M 1999 Phylogenetic analysis of the cultivated and wild species of *Phaseolus* (Fabaceae). *Syst. Bot.* 24, 438–460.
- Dellagi A, Birch P R, Heilbronn J, Lyon G D and Toth I K 2000 cDNA-AFLP analysis of differential gene expression in the prokaryotic plant pathogen *Erwinia carotovora*. *Microbiology* 146, 165–171.
- Dillen W, De Clercq J, Goosens A, Van Montagu M and Angenon G 1997a. *Agrobacterium*-mediated transformation of *Phaseolus acutifolius* A. Gray. *Theor. Appl. Genet.* 94, 151–158.
- Dillen W, De Clercq J, Kapila J, Zambre M, Van Montagu M and Angenon G 1997b The effect of temperature on *Agrobacterium tumefaciens*-mediated gene transfer to plants. *Plant J.* 12(6), 1459–1463.
- Ditt R F, Nester E W and Comai L 2001 Plant gene expression response to *Agrobacterium tumefaciens*. *Proc. Natl. Acad. Sci. USA* 98, 10954–10959.
- Dong Y, Glasner J D, Blattner F R and Triplett E W 2001 Genomic interspecies microarray hybridization: rapid discovery of three thousand genes in the maize endophyte, *Klebsiella pneumoniae* 342, by microarray hybridization with *Escherichia coli* K-12 open reading frames. *Appl. Environ. Micro.* 67, 1911–1921.
- Drevon J J and Hartwig U Phosphorus deficiency increases the argon-induced decline of nodule nitrogenase activity in soybean and alfalfa. *Planta* 201, 463–469.
- Dumon C, Priem B, Martin S-L, Heyraud A, Bosso C and Samain E 2002 *In vivo* fucosylation of recombinant lacto-*N*-neotetraose and lacto-*N*-hexaose by heterologous expression of -1,3 fucosyltransferase of *Helicobacter pylori* in engineered *Escherichia coli* Glycoconj. J. (In press).
- Durrant W E, Rowland O, Piedras P, Hammond-Kosack K E and Jones J D 2000 cDNA-AFLP reveals a striking overlap in race-specific resistance and wound response gene expression profiles. *Plant Cell* 12, 963–977.
- Eggermont K, Goderis I J and Broekaert W F 1996 High-throughput RNA extraction from plant samples based on homogenisation by reciprocal shaking in the presence of a mixture of sand and glass beads. *Plant Mol. Biol. Rep.* 14, 273–279.
- El-Tohamy W, Schnitzler W H, El-Bahairy U and El-Beltagy M S 1999 The effect of VA mycorrhizal on improving drought and chilling tolerance on bean plants (*Phaseolus vulgaris* L.). *J. Appl. Bot.* 73, 178–183. 102, 353–359.
- Escribano M R, De Ron A M and Amurrio J M 1994 Diversity in agronomical traits in common bean populations from Northwestern Spain. *Euphytica* 76, 1–6.
- Escribano M R, Santalla M and De Ron A M 1997 Genetic diversity in pod and seed quality traits of common bean populations from northwestern Spain. *Euphytica* 93, 71–81.

- Escribano M R, Santalla M, Casquero P A and De Ron A M 1998 Patterns of genetic diversity in landraces of common bean (*Phaseolus vulgaris* L.) from Galicia. *Plant Breeding* 117, 49–56.
- Fariás-Rodríguez R, Mellor R B, Arias C and Peña Cabrales J J 1998 The accumulation of trehalose in nodules of several cultivars of common bean (*Phaseolus vulgaris*) and its correlation with resistance to drought stress. *Physiol. Plant.* 102, 353–359.
- Fellay R, Perret X, Viprey V, Broughton W J and Brenner S 1995 Organisation of host-inducible transcripts on the plasmid of *Rhizobium* sp. NGR234. *Mol. Microbiol.* 16, 657–667.
- Fernandez-Toledo F, Beaver J S and Schröder E C 1997 Nodulation and seed yield of common bean in moderate and high temperature environments. *Bean Improvement Cooperative (BIC)* 40, 55–56.
- Ferrier-Cana E, Geffroy V, Macadré M, Creusot F, Prune Imbert-Bolloré P, Sévignac M and Langin T 2003 Characterization of expressed NBS-LRR resistance gene candidates from common bean. *Theor. Appl. Genet.* 106: 251–261
- Fofana B, Baudoin J P, Vekemans X, Deboucq D G and du Jardin P 1999 Molecular evidence for an Andean origin and a secondary gene pool for the Lima bean (*Phaseolus lunatus*) using chloroplast DNA. *Theor. Appl. Genet.* 98, 202–212.
- Fofana B, du Jardin P and Baudoin J P 2001 Genetic diversity in the Lima bean (*Phaseolus lunatus* L.) as revealed by chloroplast DNA (cpDNA) variations. *Genet. Resour. Crop Evol.* 48, 437–445.
- Food and Agriculture Organization of the United Nations 2001 FAOSTAT Agriculture Data. <http://www.fao.org>. Statistics (FAOSTAT).
- Freiberg C, Fellay R, Bairoch A, Broughton W J, Rosenthal A and Perret X 1997 Molecular basis of symbiosis between *Rhizobium* and legumes. *Nature* 387, 394–401.
- Freyre R, Skroch P W, Geffroy V, Adam-Blondon A-F, Shirmohamadalil A, Johnson W C, Llaca V, Nodari R O, Pereira P A, Tsai S-M, Tohme J, Dron M, Nienhuis J, Vallejos C E and Gepts P 1998 Towards an integrated linkage map of common bean. 4. Development of a core map and alignment of RFLP maps. *Theor. Appl. Genet.* 97, 847–856.
- Fuentes S I, Allen D J, Ortíz-López A and Hernández G 2001 Over-expression of cytosolic glutamine synthetase increases photosynthesis and growth at low nitrogen concentrations. *J. Exp. Bot.* 52, 1071–1081.
- Garay-Arroyo A, Colmenero-Flores J M, Garcarrubio A and Covarrubias A A 2000 Highly hydrophilic proteins are common during water deficit situations in different organisms. *J. Biol. Chem.* 275: 5668–5674.
- Garber K, Bilic I, Pusch O, Tohme J, Bachmair A, Schweizer D and Jantsch V 1999 The Tpv2 family of retrotransposons of *Phaseolus vulgaris*: structure, integration characteristics, and use for genotype classification. *Plant Mol. Biol.* 39, 797–807.
- García-Gómez B I, Hernández M, Campos F and Covarrubias A A 2000 Plant extracellular matrix proteins induced by water deficit are related to proline-rich-proteins and interact with plasma membrane. *The Plant Journal* 22, 277–288.
- Geerts P 2001 Study of embryo development in *Phaseolus* in order to obtain interspecific hybrids. Ph.D. Thesis. Gembloux Agricultural University, Belgium. 183 pp.
- Geerts P, Mergai G and Baudoin J P 1999 Rescue of early heart-shaped embryos and plant regeneration of *Phaseolus polyanthus* Greenm. and *P. vulgaris* L. *Biotechnol. Agron. Soc. Environ.* 3(3), 141–148.
- Geerts P, Toussaint A, Mergai G and Baudoin J P 2002 Study of the early abortion in reciprocal crosses between *Phaseolus vulgaris* and *Phaseolus polyanthus* Greenm. *Biotechnol. Agron. Soc. Environ.* 6, 109–119.
- Geffroy V, Creusot F, Falquet J, Sévignac M, Adam-Blondon A-F, Bannerot H, Gepts P and Dron M 1998 A family of LRR sequences in the vicinity of the *Co-2* locus for anthracnose resistance in *Phaseolus vulgaris* and its potential use in marker-assisted selection. *Theor. Appl. Genet.* 96, 494–502.
- Geffroy V, Sévignac M, De Oliveira J, Fouilloux G, Skroch P, Thoquet P, Gepts P, Langin T and Dron M 2000 Inheritance of partial resistance against *Colletotrichum lindemuthianum* in *Phaseolus vulgaris* and co-localization of QTL with genes involved in specific resistance. *Molec. Plant Microbe Interact.* 13, 287–296.
- Geffroy V, Sicard D, de Oliveira J, Sévignac M, Cohen S, Gepts P, Neema C and Dron M 1999 Identification of an ancestral resistance gene cluster involved in the coevolution process between *Phaseolus vulgaris* and its fungal pathogen *Colletotrichum lindemuthianum*. *Molec. Plant Microbe Interact.* 12, 774–784.
- Gehring C A 1999 Natriuretic peptides – A new class of plant hormone? *Ann. Bot.* 83, 329–334.
- Gehring C A, Irving H R, Kabbara A A, Parish R W, Boukli N M and Broughton W J 1997 Rapid, plateau-like increases in intra-cellular free calcium are associated with Nod-factor induced root-hair deformation. *Mol. Plant-Microbe Interact.* 10, 791–802.
- Gepts P 1998 Origin and evolution of common bean: past events and recent trends. *HortScience* 33, 1124–1130.
- Gepts P 1999a A phylogenetic and genomic analysis of crop germplasm: a necessary condition for its rational conservation and utilization. *In Proc. Stadler Symposium*. Ed. J Gustafson. pp. 163–181. Plenum.
- Gepts P 1999b Development of an integrated genetic linkage map in common bean (*Phaseolus vulgaris* L.) and its use. *In Bean Breeding for the 21st Century*. Ed. S Singh. pp. 53–91, 389–400. Kluwer.
- Gepts P and Bliss F A 1984 Enhanced available methionine concentration associated with higher phaseolin levels in common bean seeds. *Theor. Appl. Genet.* 69, 47–53.
- Gepts P and Bliss F A 1985 F_1 hybrid weakness in the common bean: differential geographic origin suggests two gene pools in cultivated bean germplasm. *J. Hered.* 76, 447–450.
- Gepts P 1998b What can molecular markers tell us about the process of domestication in common bean? *In The Origins of Agriculture and Crop Domestication*. Eds. A Damania et al. pp. 198–209. ICARDA, Aleppo, Syria.
- Gil J and De Ron A M 1992 Variation in *Phaseolus vulgaris* in the northwest of the Iberian Peninsula. *Plant Breeding* 109, 313–319.
- González V, Bustos P, Ramírez-Romero M A, Medrano-Soto A, Salgado H, Hernández-González I, Hernández-Celis C, Quintero V, Moreno-Hagelsieb G, Girard L, Rodríguez O, Flores M, Cevallos M A, Collado-Vides J, Romero D and Dávila G 2002 The mosaic structure of the symbiotic plasmid of *Rhizobium etli* CFN42 and its relation with other symbiotic genome compartments (Submitted to *Genome Biology*).
- Goossens A, Dillen W, De Clercq J, Van Montagu M and Angenon G 1999a The arcelin-5 gene of *Phaseolus vulgaris* directs high seed-specific expression in transgenic *Phaseolus acutifolius* and *Arabidopsis* plants. *Plant Physiol.* 120(4), 1095–1103.
- Goossens A, Dillen W, De Clercq J, Van Montagu M and Angenon G 1999a The arcelin-5 gene of *Phaseolus vulgaris* directs high seed-specific expression in transgenic *Phaseolus acutifolius* and *Arabidopsis* plants. *Plant Physiol.* 120, 1095–1103.
- Goossens A, Van Montagu M and Angenon G 1999b Co-introduction of an antisense gene for an endogenous seed

- storage protein can increase expression of a transgene in *Arabidopsis thaliana* seeds. FEBS Lett 456, 160–164.
- Gornicki J P, Farris, King I, Podkowinski J, Gill B, and Haselkorn R 1997 Plastid-localized acetylCoA carboxylase of bread wheat is encoded by a single gene on each of the three ancestral chromosome sets. Proc. Natl. Acad. Sci. USA 94, 14179–14284.
- Gornicki P and Haselkorn R 1993a Wheat acetyl-CoA carboxylase. Plant Mol. Biol. 22, 547–552.
- Gornicki P, Podkowinski J, Scappino L A, DiMaio J, Ward E and Haselkorn R 1994 Wheat acetyl-coenzyme A carboxylase: cDNA and protein structure. Proc. Natl. Acad. Sci. USA 91, 6860–6864.
- Gornicki P, Scappino L and Haselkorn R 1993b Genes for two subunits of acetyl coenzyme A carboxylase of *Anabaena* sp. strain PCC 7120: biotin carboxylase and biotin carboxyl carrier protein. J. Bacteriol. 175, 5268–5272.
- Gressent F, Drouillard S, Mantegazza N, Samain E, Geremia R A, Canut H, Niebel A, Driguez H, Ranjeva R, Cullimore J and Bono J J 1999 Ligand specificity of a high-affinity binding site for lipochitooligosaccharidic Nod factors in *Medicago* cell suspension cultures. Proc. Natl. Acad. Sci. USA 96, 4704–4709 26.
- Guillén G, Valdés-López V, Nogues R, Olivares J, Rodríguez-Zapata L C, Pérez H, Vidali L, Villanueva M A and Sánchez F 1999 Profilin in *Phaseolus vulgaris* is encoded by two genes (only one expressed in root nodules) but multiple isoforms are generated *in vivo* by phosphorylation on tyrosine residues. Plant J. 19, 497–508.
- Hardarson G, Bliss F A, Cigalesrivero M R, Henson R A, Kipenolt J A, Longeri L, Manrique A, Penacabriales J J, Pereira P A A, Sanabria C A, Tsai S M 1993 Genotypic variation in biological nitrogen-fixation by common bean. Plant and Soil 152(1): 59–70.
- Hertford R and García J A 1999 Competitividad de la agricultura en las Américas. Centro Internacional de Agricultura Tropical (CIAT), Cali, Colombia. 88 pp.
- Hicke L 2001 Protein regulation by monoubiquitin. Nature Rev. Molec. Cell Biol. 2: 195–201.
- Hippler M, Klein J, Allinger T and Hoerth P 2001 Towards functional proteomics of membrane protein complexes: analysis of thylakoid membranes from *Chlamydomonas reinhardtii*. Plant J. 28, 595–606.
- Hitz W D, Carlson J C, Kerr P S and Sebastian S A 2002 Biochemical and molecular characterization of a mutation that confers a decreased raffinose and phytic acid phenotype on soybean seeds. Plant Physiol. 128, 650–660.
- Hucl P and Scoles G J 1985 Interspecific hybridization in the common bean: a review. HortScience 20, 352–357.
- Hutvagner G, Mlynarova L and Nap J P 2000 Detailed characterization of the post-transcriptional gene-silencing-related small RNA in a GUS gene-silenced tobacco RNA 6, 1445–1454.
- Ingram J and Bartels D 1996 The molecular basis of dehydration tolerance in plants. Annu. Rev. Plant Physiol. Plant Mol. Biol. 47, 377–403.
- Irving H I, Boukli N M, Kelly M N and Broughton W J 2000 Nod-factors in symbiotic development of root-hairs. In Root Hairs Cell and Molecular Biology. Eds. R W Ridge and A M Emons. pp. 241–265. Springer-Verlag, Tokyo.
- Ishimoto M 1999 Evaluation and use of wild *Phaseolus* species in breeding. In The Seventh Ministry of Agriculture, Forestry and Fisheries (MAFF), Japan. Eds. K Oono, D Vaughan, N Tomooka, A Kaga and S Miyazaki. pp. 183–190. International Workshop on Genetic Resources, Ibaraki, Japan.
- Jansen R C and Nap J P 2001 Genetical genomics, the added value from segregation. Trends Genet. 17, 388–391.
- Jeffreys A J, Kauppi L and Neumann R 2001 Intensely punctate meiotic recombination in the class II region of the major histocompatibility complex. Nature Genet. 29, 217–222.
- Joachimiak M, Tevzadze G, Podkowinski J, Haselkorn R and Gornicki P 1997 Wheat cytosolic acetylCoA carboxylase complements an *ACC1* null mutation in yeast. Proc. Nat. Acad. Sci. USA 94, 9990–9995.
- Johnson W and Gepts P 1999 Segregation for performance in recombinant inbred populations resulting from inter-gene pool crosses of common bean (*Phaseolus vulgaris* L.). Euphytica 106, 45–56.
- Jung G, Coyne D, Skroch P, Nienhuis J, Arnaud-Santana E, Bokosi J, Ariyaratne H, Steadman J, Beaver J, Kaeppler S 1996 Molecular markers associated with plant architecture and resistance to common blight, web blight, and rust in common beans. J. Amer. Soc. Hort. Sci. 121, 794–803.
- Kami J, Becerra Velásquez B, Debouck D G and Gepts P 1995 Identification of presumed ancestral DNA sequences of phaseolin in *Phaseolus vulgaris*. Proc. Natl. Acad. Sci. USA 92, 1101–1104.
- Kelly J, Kolkman J, Schneider K 1998 Breeding for yield in dry bean (*Phaseolus vulgaris* L.). Euphytica 102, 343–356.
- Kelly J D 2000 Remaking bean plant architecture for efficient production. Adv. Agron. 71, 109–143.
- Kelly J D and Miklas P N 1998 The role of RAPD markers in breeding for disease resistance in common bean. Mol. Breed. 4, 1–11.
- Kelly J D, Kolkman J M and Schneider K 1998 Breeding for yield in dry bean (*Phaseolus vulgaris* L.). Euphytica 102, 343–356.
- Kelly M N and Irving H R 2001 Nod factors stimulate plasma membrane delimited phospholipase C activity *in vitro*. Physiol. Plant. 113, 461–468.
- Kelly M N and Irving H R 2003 Nod factors activate both heterotrimeric and monomeric G-proteins in *Vigna unguiculata* (L.) Walp. Planta, 216, 674–685.
- Kigel J 1999 Culinary and nutritional quality of *Phaseolus vulgaris* seeds as affected by environmental factors. Biotech. Agron. Soc. Environ. 3, 205–209.
- Kim J W and Minamikawa T 1996 Transformation and regeneration of French bean plants by the particle bombardment process. Plant Sci. 117, 131–138.
- Knowles J R 1989 The mechanism of biotin-dependent enzymes. Annu. Rev. Biochem. 58: 195–221.
- Koinange E M K and Gepts P 1992 Hybrid weakness in wild *Phaseolus vulgaris* L. J. Hered. 83, 135–139.
- Koinange E M K, Singh S P and Gepts P 1996 Genetic control of the domestication syndrome in common-bean. Crop Sci. 36, 1037–1045.
- Kolkman J M, Kelly J D 2002 QTL conferring resistance and avoidance to white mold (*Sclerotinia sclerotiorum*) in common bean (*Phaseolus vulgaris*), submitted for publication.
- Kornegay J and Cardona C 1991 Breeding for insect resistance in beans. In Common Beans: Research for Crop Improvement. Eds. A van Schoonhoven and O Voysest. pp. 619–648. CAB International, Wallingford, UK.
- Krause A and Broughton W J 1992 Proteins associated with root-hair deformation and nodule initiation in *Vigna unguiculata*. Mol. Plant-Microbe Interact. 5, 96–103.
- Krause A, Sigrist C J A, Dehning I, Sommer H and Broughton W J 1994 Accumulation of LTP transcripts during deformation of nodulation competent root-hairs. Mol. Plant-Microbe Interact. 7, 411–418.
- Kreitman M and Akashi H 1995 Molecular evidence for natural selection. Ann. Rev. Ecol. Syst. 26, 403–422.
- Kulikova O, Gualtieri G, Geurts R, Kim D-J, Cook D, Huguet T, de Jong J H, Fransz P F and Bisseling T 2001 Integration of

- the FISH pachytene and genetic maps of *Medicago truncatula*. *Plant J.* 27, 49–58.
- Lara M, Porta H, Padilla J, Folch J and Sánchez F 1984 Heterogeneity of glutamine synthetase polypeptides in *Phaseolus vulgaris* L. *Plant Physiol.* 76, 1019–1023.
- Larson S R, Rutger J N, Young K A and Raboy V 2000 Isolation and genetic mapping of a non-lethal rice (*Oryza sativa* L.) low phytic acid mutation. *Crop Sci.* 40, 1397–1405.
- Lavin M, Doyle J J and Palmer J D 1990 Evolutionary significance of the loss of the chloroplast-DNA inverted repeat in the Leguminosae subfamily Papilionoideae. *Evolution* 44, 390–402.
- Lecomte B, Longly B, Crabbe J and Baudoin J P 1998 Etude comparative du développement de l'ovule chez deux espèces de *Phaseolus*: *P. polyanthus* et *P. vulgaris*. Développement de l'ovule dans le genre *Phaseolus*. *Biotechnol. Agron. Soc. Environ.* 2(1), 77–84.
- Lewin A, Rosenberg C, Meyer z A H, Wong C-H, Nelson L, Manen J-F, Stanley J, Dowling D N, Dénarié J and Broughton W J 1987 Multiple host-specificity loci of the broad host range *Rhizobium* sp. NGR 234 selected using the widely compatible legume *Vigna unguiculata*. *Plant Mol. Biol.* 8, 447–459.
- Lewis T 1997 Chemical control. In *Thrips as Crop Pests*. Ed. T Lewis. pp. 567–593. CAB International, Wallingford, UK.
- Limongelli G, Laghetti G, Perrino P and Piergiovanni A R 1996 Variation of seed storage proteins in landraces of common bean (*Phaseolus vulgaris* L.) from Basilicata, Southern Italy. *Euphytica* 92, 393–399.
- Lioi L and Hammer K 1993 A note on the variation of phaseolin among common bean landraces collected in eastern Asia. *Genet. Resour. Crop Evolut.* 40, 55–57.
- Lioi L, Lotti C and Galasso I 1998 Isozyme diversity, RFLP of the rDNA and phylogenetic affinities among cultivated Lima beans, *Phaseolus lunatus* (Fabaceae). *Plant System. Evolut.* 213, 153–164.
- Lolas G M and Markakis P 1975 Phytic acid and other phosphorous compounds of beans (*Phaseolus vulgaris* L.). *J. Agric. Food Chem.* 23, 13–15.
- Lott J N A, Ockenden I, Raboy V and Batten G D 2000 Phytic acid and phosphorous in crop seeds and fruits: a global estimate. *Seed Sci. Res.* 19, 11–33.
- Ludidi N N, Heazlewood J L, Seoighe C J, Irving H R and Gehring C A 1998 Expansin-like molecules: Novel functions derived from common domains. *J. Mol. Evol.* 54, 587–594.
- Ma Y and Bliss F A 1978 Seed proteins of common bean. *Crop Sci.* 17, 431–437.
- Mabberley D J 1998 *The Plant Book*. Cambridge University Press, Cambridge. 706 pp.
- Macas J, Dolezel J, Gualberti G, Pich U, Schubert I and Lucretti S 1995 Primer-induced labelling of pea and field bean chromosomes *in situ* and in suspension. *BioTechniques* 19, 402–408.
- Macas J, Dolezel J, Lucretti S, Pich U, Meister A, Fuchs J and Schubert I 1993a Localization of seed protein genes on flow-sorted field bean chromosomes. *Chromosome Res.* 1, 107–115.
- Macas J, Gualberti G, Nouzova M, Samec P, Lucretti S and Dolezel J 1996 Construction of chromosome-specific DNA libraries covering whole genome of field bean (*Vicia faba* L.). *Chromosome Res.* 4, 531–539.
- Macas J, Meszaros T and Nouzova M 2002 PlantSat: a specialized database for plant satellite repeats. *Bioinformatics* 18, 28–35.
- Macas J, Pozarkova D, Navratilova A, Nouzova M and Neumann P 2000 Two new families of tandem repeats isolated from genus *Vicia* using genomic self-priming PCR. *Mol. Gen. Genet.* 263, 741–751.
- Macas J, Weschke W, Baumlain H, Pich U, Houben A, Wobus U and Schubert I 1993b Localization of vicilin genes via polymerase chain reaction on microisolated field bean chromosomes. *Plant J.* 3, 883–886.
- Maynard Smith J and Haigh J 1974 The hitch-hiking effect of a favourable gene. *Genet. Res.* 23, 23–35.
- Maleck K, Levine A, Eulgem T, Morgan A, Schmid J, Lawton K A, Dangl J L and Dietrich R A 2000 The transcriptome of *Arabidopsis thaliana* during systemic acquired resistance. *Nat. Genet.* 26, 403–410.
- Maquet A, Vekemans X and Baudoin J P 1999 Phylogenetic study on wild allies of Lima bean and implication on its origin. *Plant Syst. Evol.* 218, 43–54.
- Martínez T, Santalla M and De Ron A M 2002 Preliminary evaluation of scarlet bean landraces from Spain. *Ann. Rep. Bean Imp. Coop* 45, 60–61.
- Maryani M M, Bradley G, Cahill D M and Gehring C A 2001 Natriuretic peptides and immunoreactants enhance osmoticum-dependent volume changes in *Solanum tuberosum* L. mesophyll protoplasts. *Plant Sci.* 161, 443–452.
- McClean P, Chee P, Held B, Simental J, Drong R F and Slightom J 1991 Susceptibility of dry bean (*Phaseolus vulgaris* L.) to *Agrobacterium* infection: transformation of cotyledonary and hypocotyl tissues. *Plant Cell Tiss. Org. Cult.* 24, 131–138.
- Mejía-Jiménez A, Muñoz C, Jacobsen H J, Roca W M and Singh S P 1994 Interspecific hybridization between common and tepary beans: increased hybrid embryo growth, fertility, and efficiency of hybridisation through recurrent and congruity backcrossing. *Theor. Appl. Genet.* 88, 324–331.
- Melotto M and Kelly J D 2001 Fine mapping of the *Co-4* locus of common bean reveals a resistance gene candidate *COK-4* that encodes for a protein kinase. *Theor. Appl. Genet.* 103, 508–517.
- Messina M J 1999 Legumes and soybeans: overview of their nutritional profiles and health effects. *Amer. J. Clin. Nutr.* 70 (suppl), 439S–450S.
- Metais I, Aubry C, Hamon B, Peltier D and Jalouzet R 1998 Cloning, quantification and characterization of a minisatellite DNA sequence from common bean *Phaseolus vulgaris* L. *Theor. Appl. Genet.* 97, 232–237.
- Michiels J, Dombrecht B, Vermeiren N, Xi C, Luyten E and Vanderleyden J 1998 *Phaseolus vulgaris* is a non-selective host for nodulation. *FEMS Microb. Ecol.* 26, 193–205.
- Midorikawa K, Murata M, Oikawa S, Hiraku Y and Kawanishi S 2001 Protective effect of phytic acid on oxidative DNA damage with reference to cancer chemoprevention. *Biochem. Biophys. Res. Commun.* 288, 552–557.
- Miklas P N, Johnson E, Stone V, Beaver J S, Montoya C, Zapata M 1996 Selective mapping of QTL conditioning disease resistance in common bean. *Crop Sci.* 36, 1344–1351.
- Miklas P N, Delorme R, Stone V, Daly M J, Stavely J R, Steadman J R, Bassett M J, Beaver J S 2000a Bacterial, fungal, virus disease loci mapped in a recombinant inbred common bean population ('Dorado/XAN176'). *J. Am. Soc. Hort. Sci.* 125, 476–481.
- Miklas P N, Larsen R C, Riley R, Kelly J D 2000b Potential marker-assisted selection for *bc-1²* resistance to bean common mosaic potyvirus in common bean. *Euphytica* 116, 211–219.
- Mitchell-Olds T, Gershenzon J, Baldwin I and Boland W 1998 Chemical ecology in the molecular era. *Trends Plant Sci.* 3(9), 362–365.
- Mlýnářová L, Keizer L C P, Stiekema W J and Nap J P 1996 Approaching the lower limits of transgene variability. *Plant Cell* 8, 1589–1599.

- Monteagudo A B, Rodiño A P, Montero I, Santalla M and De Ron A M 2000 Breeding white seeded bean cultivars for improving quality. *Ann. Rep. Bean Improvement Cooperative* 43, 47–48.
- Morales F J and Singh S P 1991 Genetics of resistance to bean golden mosaic virus in *Phaseolus vulgaris* L. *Euphytica* 52, 113–117.
- Moreno-Fonseca L P and Covarrubias A A 2001 Downstream DNA sequences are required to modulate *Pvlea-18* gene expression in response to dehydration. *Plant Mol. Biol.* 45: 501–515.
- Moscone E A, Klein F, Lambrou M, Fuchs J and Schweizer D 1999. Quantitative karyotyping and dual-color FISH mapping of 5S and 18S–25S rDNA probes in the cultivated *Phaseolus* species (Leguminosae). *Genome* 42, 1224–1233.
- Murray J D, Michaels T E, Pauls K P and Schaafsma A W 2001 Determination of traits associated with leafhopper (*Empoasca fabae* and *Empoasca kraemeri*) resistance and dissection of leafhopper damage symptoms in the common bean (*Phaseolus vulgaris*). *Annals Appl. Biol.* 139, 319–327.
- Nap J P, Conner A J, Mlynarova L, Stiekema W J and Jansen R C 1997 Dissection of a synthesized quantitative trait to characterize transgene interactions. *Genetics* 147, 315–320.
- Nei M 1987 Molecular evolutionary genetics. Columbia University Press, New York.
- Neto E D, Harrop R, Correa-Oliveira R, Wilson R A, Pena S D J and Simpson A J G 1997 mini-libraries constructed from cDNA by arbitrarily primed RT-PCR: an alternative to normalized libraries for the generation of ESTs from nanogram quantities of mRNA. *Gene* 186, 135–142.
- Neumann P, Nouzova M and Macas J 2001 Molecular and cytogenetic analysis of repetitive DNA in pea (*Pisum sativum* L.). *Genome* 44, 716–728.
- Newman J D, Schultz B W and Noel K D 1992 Dissection of nodule development by supplementation of *Rhizobium leguminosarum* biovar *phaseoli* purine auxotrophs with AICA riboside. *Plant Physiol.* 99, 401–408.
- Nodari R O, Tsai S M, Guzmán P, Gilbertson R L and Gepts P 1993 Towards an integrated linkage map of common bean. 3. Mapping genetic factors controlling host–bacteria interactions. *Genetics* 134, 341–350.
- Noel K D, Forsberg L S and Carlson R W 2000 Varying the abundance of O-antigen in *Rhizobium etli* and its effect on the symbiosis with *Phaseolus vulgaris*. *J. Bacteriol.* 182, 5317–5324.
- Nouwens A S, Cordwell SJ, Larsen M R, Molloy M A, Gillings M, Willcox M and Walsh B J 2000 Complementing genomics with proteomics: The membrane subproteome of *Pseudomonas aeruginosa* PA01. *Electrophoresis* 21, 3797–3809.
- Nouzova M, Kubalaková M, Doleželová M, Koblízková A, Neumann P, Doležel J and Macas J 1999 Cloning and characterization of new repetitive sequences in field bean (*Vicia faba* L.). *Ann. Bot.* 83, 535–541.
- Nouzova M, Neumann P, Navratilová A, Galbraith D W and Macas J 2001 Microarray-based survey of repetitive genomic sequences in *Vicia* spp. *Plant Mol. Biol.* 45, 229–244.
- Nümberger T and Scheel D 2001 Signal transmission in the plant immune response. *Trends Plant Sci.* 6, 372–379.
- Ortega J L, Sanchez F, Soberon M and Lara M 1992 Regulation of nodule glutamine synthetase by CO₂ levels in beans (*Phaseolus vulgaris* L.) *Plant Physiol.* 98, 584–587.
- Pachico D 1982 Beans in Latin America. In *Trends in CIAT Commodities*. Internal Document, Economics 1.7. Centro Internacional de Agricultura Tropical (CIAT), Cali, Colombia, pp. 1–55.
- Padilla J, Campos F, Lara M and Sanchez F 1987 Nodule specific glutamine synthetase is expressed before the onset of nitrogen fixation in *Phaseolus vulgaris* L. *Plant Mol. Biol.* 9, 65–74.
- Papa R and Gepts P 2000 Map-based analysis of population differentiation and gene flow in *Phaseolus vulgaris*. *Plant and Animal Genome VIII*. January 9–12, San Diego.
- Papa R and Gepts P 2003 Asymmetry of gene flow and differential geographical structure of molecular diversity in wild and domesticated common bean (*Phaseolus vulgaris* L.) from Mesoamerica. *Theor. Appl. Genet.* 106, 239–250.
- Park S, Coyne D P, Jung G, Skroch P W, Arnaud-Santana E, Steadman J, Ariyaratne H, Nienhuis J 2000 Mapping of QTL for seed size and shape traits in common bean. *J. Amer. Soc. Hort. Sci.* 125, 466–475.
- Park S O, Coyne D P, Steadman J R, Skroch P W 2001 Mapping of QTL for resistance to white mold disease in common bean. *Crop Sci.* 41, 1253–1262.
- Patton D A, Schetter A L, Franzmann L H, Nelson K, Ward E R and Neinke D W 1998 An embryo-defective mutant of *Arabidopsis* disrupted in the final step of biotin synthesis. *Plant Physiol.* 116, 935–946.
- Patton D A, Johnson M and Ward E R 1996a Biotin synthase from *Arabidopsis thaliana*. cDNA isolation and characterization of gene expression. *Plant Physiol.* 112, 371–378.
- Patton D A, Volrath S and Ward E R 1996b Complementation of an *Arabidopsis thaliana* biotin auxotroph with an *Escherichia coli* biotin biosynthetic gene. *Mol. Gen. Genet.* 251, 261–266.
- Pedrosa A, Sandal N, Stougaard J, Schweizer D and Bachmair A 2002a. Chromosomal map of the model legume *Lotus japonicus*. *Genetics* 161, 1661–1672.
- Pedrosa A, Vallejos C E, Bachmair A and Schweizer D 2001 Integrating common bean (*Phaseolus vulgaris* L.) linkage and chromosomal maps. *Ann. Rep. Bean. Impr. Coop.* 44, 11–12.
- Pedrosa A, Vallejos C E, Bachmair A and Schweizer D 2002b Integration of common bean (*Phaseolus vulgaris* L.) linkage and chromosomal maps. *Theor. Appl. Genet.* (In press).
- Peix A, Mateos P F, Rodríguez-Barrueco C, Martínez-Molina E and Velaquez E 2001 Growth promotion of common bean (*Phaseolus vulgaris* L.) by a strain of *Burkholderia cepacia* under growth chamber conditions. *Soil Biol. Biochem.* 33, 1927–1935.
- Pennington J A T and Young B 1990a Sodium, potassium, calcium, phosphorus and magnesium in foods from the United States total diet study. *J. Food Comp. Anal.* 3, 145–165.
- Pennington J A T and Young B 1990b Iron, zinc, copper, manganese, selenium and iodine in foods from the United States total diet study. *J. Food Comp. Anal.* 3, 166–184.
- Perdomo F, Echávez-Badel R, Alameda M and Schröder E C 1995 In vitro evaluation of bacteria for the biological control of *Macrophomina phaseolina*. *World J. Microbiol. Biotechnol.* 11, 183–185.
- Perret X, Freiberg C, Rosenthal A, Broughton W J and Fellay R 1999 High-resolution transcriptional analysis of the symbiotic plasmid of *Rhizobium* sp. NGR234. *Mol. Microbiol.* 32, 415–425.
- Petersen D J, Srinivasan M and Chanway C P 1996 *Bacillus polymyxa* stimulates increased *Rhizobium etli* populations and nodulation when co-resident in the rhizosphere of *Phaseolus vulgaris*. *FEMS Lett.* 142, 271–276.
- Pharmawati M, Gehring C A and Irving H R 1998 An immunoaffinity purified plant natriuretic peptide analogue modulates cGMP levels in the *Zea mays* root stele. *Plant Sci.* 137, 107–115.
- Pharmawati M, Maryani M M, Nikolakopoulos T, Gehring C A and Irving H R 2001 Cyclic GMP modulates stomatal opening

- induced by natriuretic peptides and immunoreactive analogues in *Vicia faba*. Plant Physiol. Biochem. 39, 385–394.
- Pharmawati M, Shabala S N, Newman I A and Gehring C A 1999 Natriuretic peptides and cGMP modulate K⁺, Na⁺ and H⁺ fluxes in *Zea mays* roots. Mol. Cell Biol. Res. Comm. 2, 53–57.
- Pich U, Meister A, Macas J, Dolezel J, Lucretti S and Schubert I 1995 Primed *in situ* labelling facilitates flow sorting of similar sized chromosomes. Plant J. 7, 1039–1044.
- Pickett J A and Poppy G M 2001 Switching on plant genes by external chemical signals. Trends Plant Sci. 6(4), 137–139.
- Piergiorgio A R, Cerbino D and Della Gatta C 2000 Diversity in seed quality traits of common bean (*Phaseolus vulgaris* L.) populations from Basilicata (Southern Italy). Plant Breeding 119, 513–516.
- Podkowinski J, Sroga G E, Haselkorn R and Gornicki P 1996 Structure of a gene encoding a cytosolic acetyl-CoA carboxylase of hexaploid wheat. Proc. Natl. Acad. Sci. USA 93, 1870–1874.
- Polhill R M 1981 Papilionoideae. In Advances in Legume Systematics, Part 1. Eds R M Polhill and P H Raven. pp. 191–205. Royal Botanic Gardens, Kew, Richmond, Surrey.
- Polhill R M 1994 Classification of the Leguminosae. In Phytochemical Dictionary of the Leguminosae, Vol. 1. Plants and their Constituents. Eds F A Bisby, J Buckingham and J B Harborne. pp. xvi–xxxvii. Chapman and Hall, London.
- Pueppke S G and Broughton W J 1999 *Rhizobium* sp. NGR234 and *R. fredii* USDA257 share exceptionally broad, nested host-ranges. Mol. Plant-Microbe Interact. 12, 293–318.
- Qin L, Overmars H, Helder J, Popeijus H, van der Voort J R, Groenink W and van Koert P 2000 An efficient cDNA-AFLP-based strategy for the identification of putative pathogenicity factors from the potato cyst nematode *Globodera rostochiensis*. Mol. Plant Microbe Interact. 13, 830–836.
- Raboy V, Gerbasi P F, Young K A et al. 2000 Origin of seed phenotype of maize low phytic acid 1-1 and low phytic acid 2-1. Plant Physiol. 124, 355–368.
- Raboy V, Noamann M M, Taylor G A and Pickett S G 1991 Grain phytic acid and protein are highly correlated in winter wheat. Crop Sci. 31, 631–635.
- Ramamoorthy V, Viswanathan R, Raguchander T, Prakasam V and Samiyappan R 2001 Induction of systemic resistance by plant growth promoting rhizobacteria in crop plants against pests and diseases. Crop Prot. 20, 1–11.
- Ramamoorthy V, Viswanathan T, Raguchander T, Prakasam V and Samiyappan R 2001 Induction of systemic resistance by plant growth promoting rhizobacteria in crop plants against pests and diseases. Crop Prot. 20, 1–11.
- Reddy B S 1999 Role of dietary fiber in colon cancer: An overview. Amer. J. Med. 106(1A), 16S–19S.
- Remington D L, Thornsberry J M, Matsuoka Y, Wilson L M, Whitt S R, Doeblay J, Kresovich S, Goodman M M and Buckler E S 2001 Structure of linkage disequilibrium and phenotypic associations in the maize genome. Proc. Nat. Acad. Sci. USA 98, 11479–11484.
- Ribet J and Drevon J J 1996 The phosphorus requirement of N₂-fixing and urea-fed *Acacia mangium*. New Phytol. 132, 383–390.
- Rivkin M I, Vallejos C E and McClean P E 1999 Disease-resistance related sequences in common bean. Genome 42, 1–7.
- Robinson D 1987 Food – biochemistry and nutritional value. Longman Scientific and Technical Press. Essex, UK.
- Robzyk K, Recht J and Osley M 2000 Rad6-dependent ubiquitination of histone H2B in yeast. Science 287, 501–504.
- Rodiño A P, Monteagudo A B, Santalla M, De Ron A M 2001a Naming and release of 'Judía Peregrina', 'Alubia de Enfesta', 'Garbanzo Grande de Tuy', 'Garbanzo Capelán' and 'Mourisca', five new breeding pure lines from Spain. Ann. Rep. Bean Improvement Cooperative 44, 191–192.
- Rodiño A P, Santalla M, Montero I, Casquero P A, De Ron A M 2001b Diversity in common bean germplasm (*Phaseolus vulgaris* L.) from Portugal. Genet. Res. Crop Evolut. 48, 409–417.
- Rodiño A P, Santalla M, De Ron A M, Singh S P 2002 A core collection of common bean from the Iberian Peninsula. Euphytica (In press).
- Rosas S, Altamirano F, Schröder E C and Correa N 2001 *In vitro* biocontrol activity of *Pseudomonas aurantiaca*. Phyton (Arg.) 50, 203–209.
- Rosemeyer V, Michiels J, Verreth C, Desair J and Vanderleyden J 1998 *luxI*- and *luxR*-homologous genes of *Rhizobium etli* CN-PAF512 contribute to the synthesis of autoinducer molecules and nodulation of *Phaseolus vulgaris*. J. Bacteriol. 180, 815–821.
- Russell D R, Wallace K M, Bathe J H and Martinell B J 1993 Stable transformation of *Phaseolus vulgaris* via electric discharge mediated particle acceleration. Plant Cell Rep. 12, 165–169.
- Samain E, Chazalet V and Geremia R A 1999 Production of *O*-acetylated and sulfated chitooligosaccharides by recombinant *Escherichia coli* strains harboring different combinations of *nod* genes. J. Biotechnol. 72, 33–47.
- Samain E, Drouillard S, Heyraud A, Driguez H and Geremia R 1997 Gram scale synthesis of recombinant chitooligosaccharides in *E. coli*. Carbohydr. Res. 302, 35–42.
- Sánchez F, Padiilla J E, Pérez H and Lara M 1991 Control of nodulation genes in root-nodule development and metabolism. Annu. Rev. Plant Physiol. Plant Mol. Biol. 42, 507–528.
- Sandberg A S, Brune M, Carlsson N G, Hallberg L, Rossander-Hulthen L and Sandstrom B 1993 The effects of various inositol phosphates on iron and zinc absorption in humans. pp. 53–57. Proceedings of the International Conference on Bioavailability, 1993 – Nutrition chemical and food processing implications of nutrient availability.
- Santalla M, De Ron A M, Escribano A M 1994 Effect of intercropping bush bean populations with maize on agronomic traits and their implication for selection. Field Crops Res. 36, 185–189.
- Santalla M, De Ron A M, Casquero P A 1995 Nutritional and culinary quality of bush bean populations intercropped with maize. Euphytica 84, 57–65.
- Santalla M, Casquero P A, De Ron A M 1999a Yield and yield components from intercropping improved bush bean cultivars with maize. J. Agron. Crop Sci. 183, 263–269.
- Santalla M, Fueyo M A, Rodiño A P, Montero I, De Ron A M 1999b Breeding for culinary and nutritional quality of common bean (*Phaseolus vulgaris* L.) in intercropping systems with maize (*Zea mays* L.). Biotechnol. Agron. Soc. Environ. 3, 225–229.
- Santalla M, Amurrio J M, De Ron A M 2001a Interrelationships between cropping systems for pod and seed quality components and breeding implications in common bean. Euphytica 121, 45–51.
- Santalla M, Rodiño A P, Casquero P A, De Ron A M 2001b Interactions of bush bean intercropped with field and sweet maize. Eur. J. Agron. 15, 185–196.
- Santalla M, Amurrio J M, Rodiño A P, De Ron A M 2001c Variation in traits affecting nodulation of common bean under intercropping with maize and sole cropping. Euphytica 122, 243–255.
- Santalla M, Rodiño A P, De Ron A M 2002 Allozyme evidence supporting southwestern Europe as a secondary center of genetic diversity for common bean. Theoret. Appl. Genet. 104, 934–944.
- Sathe S K, Deshpande S S and Salunkhe D K 1984 Dry beans of *Phaseolus*. A review. Part 2. Chemical composition: Carbohydrates, fiber, minerals, vitamins and lipids. Crit. Rev. Food. Sci. Nutr. 21, 41–91.

- Schaeffer S W, Walthour C S, Toleno D M, Olek A T and Miller E L 2001 Protein variation in ADH and ADH-RELATED in *Drosophila pseudoobscura*: Linkage disequilibrium between single nucleotide polymorphisms and protein alleles. *Genetics* 159, 673–687.
- Schaaafsma A W, Cardona C, Kornegay J L, Wylde A M and Michaels T E 1998 Resistance of common bean lines to the potato leafhopper (*Homoptera: Cicadellidae*). *J. Econ. Entomol.* 91, 981–986.
- Schenk G, Guddat L W, Ge Y, Carrington L E, Hume D A, Hamilton S and De Jersey J 2000 Identification of mammalian-like purple acid phosphatases in a wide range of plants. *Gene* 250, 117–125.
- Schmit V, Baudoin J P 1992 Screening for resistance to *Ascochyta* blight in populations of *P. coccineus* L. and *P. polyanthus* Greenman. *Field Crops Res.* 30, 155–165.
- Schmit V, du Jardin P, Baudoin J P and Debouck D G 1993 Use of chloroplast DNA polymorphism for the phylogenetic study of seven *Phaseolus* taxa including *P. vulgaris* and *P. coccineus*. *Theor. Appl. Genet.* 87, 506–516.
- Schmit V, Muñoz J E, du Jardin P, Baudoin J P and Debouck D G 1995 Phylogenetic studies of some *Phaseolus* taxa on the basis of chloroplast DNA polymorphisms. In *Phaseolus* Beans Advanced Biotechnology Research Network. Proceedings of the Second International Scientific Meeting, 7–10 Sept. 1993, CIAT (Cali, Colombia). Ed. W M Roca, J E Mayer, M A Pastor-Corrales and J Tohme. pp. 69–75.
- Schneider T, Dinkins R, Robinson K, Shellhammer J and Meinke D W 1989 An embryo-lethal mutant of *Arabidopsis thaliana* is a biotin auxotroph. *Dev Biol* 131, 161–167.
- Schneider K A, Grafton K F, Kelly J D 2001 QTL analyses of resistance to *Fusarium* root rot in bean. *Crop Sci.* 41, 535–542.
- Schröder E C 1992 Improvement of the *Phaseolus/Rhizobium* symbiosis, with particular reference to the Caribbean region. In *Biological Nitrogen Fixation and Sustainability of Tropical Agriculture*. Eds. K Mulongoy, M Gueye and D S C Spencer. pp. 79–95. J. Wiley and Sons.
- Schuler T H, Poppy G M, Kerry B R and Denholm I 1998 Insect-resistant transgenic plants. *Trends Biotechnol.* 16, 168–175.
- Schweizer D and Ambros P 1979 Analysis of nucleolus organizer regions (NORs) in mitotic and polytene chromosomes of *Phaseolus coccineus* by silver staining and Giemsa C-banding. *Pl. Syst. Evol.* 132, 27–51.
- Scott M E and Michaels T E 1992 *Xanthomonas* resistance of *Phaseolus* interspecific cross selections confirmed by field performance. *HortScience* 27, 348–350.
- Segovia L, Young J P W and Martínez-Romero E 1993 Reclassification of American *Rhizobium leguminosarum* biovar phaseoli type I strains as *Rhizobium etli* sp. nov. *Int. j. Syst. Bacteriol.* 43, 374–377.
- Serraj R, Frangne E N, Maeshima M, Fleurat-Lessard P and Drevon J J 1998 A g-TIP cross-reacting protein is abundant in the cortex of soybean N₂-fixing nodules. *Planta* 206, 681–684.
- Shade R E, Schroeder H E, Pueyo J J, Tabe L M, Murdock L L, Higgins T G V and Chrispeels M J 1994 Transgenic pea seeds expressing the α -amylase inhibitor of the common bean are resistant to bruchid beetles. *Bio-Technology* 12, 793–796.
- Shah F H and Cha T S 2000 A mesocarp and species-specific clone encodes for sesquiterpene synthase in oil palm. *Plant Sci.* 154, 153–160.
- Shah F H, Omar R and Cha T S 2000 Temporal regulation of two isoforms of delta-9-stearoyl desaturase in oil Palm. *Plant Sci.* 152, 27–33.
- Shah F H, Fathurrahman I, Tan C L and Cha T S 2002 Genetic manipulation in oil palm: Strategies to get the most efficient target tissues. *Proc. 15th Int. Symp on Plant Lipids*, p. 304.
- Shamsuddin M, Vucenik I and Cole K E 1997 IP6: A novel anti-cancer agent. *Life Sci.* 61, 343–354.
- Shellhammer J and Meinke D 1990 Arrested embryos from the auxotroph of *Arabidopsis thaliana* contain reduced levels of biotin. *Plant Physiol.* 93, 1162–1167.
- Shii C T, Mok M C, Mok D W S 1981 Developmental controls of morphological mutants of *Phaseolus vulgaris* L.: differential expression of mutant loci in plant organs. *Dev. Genet.* 2, 279–290.
- Silvente S, Blanco L, Camas A, Ortega J L, Ramírez M and Lara-Flores M 2002 A *Rhizobium etli* mutant modulates carbon and nitrogen metabolism in *Phaseolus vulgaris* nodules. *Mol. Plant-Microbe Interact.* 15, 728–733.
- Singh S P 1999 Integrated genetic improvement. In *Common Bean Improvement in the 21st century*. Ed. S P Singh. pp. 133–165. Kluwer Academic Publishers, Dordrecht.
- Singh S P, Gepts P and Debouck D G 1991 Races of common bean (*Phaseolus vulgaris* L., Fabaceae). *Econ. Bot.* 45, 379–396.
- Singh S P and Molina A 1996 Inheritance of crippled trifoliolate leaves occurring in interracial crosses of common bean and its relationship with hybrid dwarfism. *J. Hered.* 87(6), 464–469.
- Smartt J 1990 *Grain Legumes. Evolution and Genetic Resources*. Cambridge Univ. Press, Cambridge, pp. 379.
- Smith P M C, Mann A J, Goggin D E, Atkins C A 1998 AIR synthetase in Cowpea Nodules: A single gene product targeted to two organelles? *Plant Molec. Biol.* 36, 811–820.
- Sonnante G, Stockton T, Nodari R O, Becerra Velásquez V L and Gepts P 1994 Evolution of genetic diversity during the domestication of common-bean (*Phaseolus vulgaris* L.). *Theor. Appl. Genet.* 89, 629–635.
- Sparvoli F, Lanave C, Santucci A, Bollini R and Lioi L 2001 Lectin and lectin-related proteins in Lima bean (*Phaseolus lunatus* L.) seeds: biochemical and evolutionary studies. *Plant Molec. Biol.* 45, 587–597.
- Sparvoli F, Faoro F, Daminati M G, Ceriotti A, Bollini R 2000 Misfolding and aggregation of vacuolar glycoproteins in plant cells. *Plant J.* 24, 825–836.
- Srinivasan M, Petersen D J and Holl F B 1996 Influence of indole acetic acid producing *Bacillus* isolates on nodulation of *Phaseolus vulgaris* by *Rhizobium etli* under gnotobiotic conditions. *Can. J. Microbiol.* 42, 1006–1014.
- Srivastava A, Strasser R J and Govindjee 1995 Polyphasic rise of chlorophyll *a* fluorescence intensity and quantum yield of photosystem II of herbicide-resistant D1 mutants of *Chlamydomonas reinhardtii*. *Photosynth. Res.* 43, 131–141.
- Staiger C 2000 Signal to the actin cytoskeleton in plants. *Annu. Rev. Plant Physiol. Plant Mol. Biol.* 51, 257–288.
- Stanley D W and Aguilera J M 1985 A review of textural defects in cooked reconstituted beans – the influence of structure and composition. *J. Food Biochem.* 9, 277–323.
- Strasser R J, Srivastava A and Govindjee 1995 Polyphasic chlorophyll *a* fluorescence transient in plants and cyanobacteria. *Photochem. Photobiol.* 61, 32–42.
- Strasser R J, Srivastava A and Tsimilli-Michael M The fluorescence transient as a tool to characterise and screen photosynthetic samples. In *Probing Photosynthesis: Mechanisms, Regulation and Adaptation*. Eds M Yunus, U Pathre and P Mohanty. Ch. 25, pp. 445–483. Taylor and Francis, London, UK.
- Streit W and Entcheva P 2003 Biotin in microbes, the genes involved in its biosynthesis, its biochemical role and perspectives for biotechnological production. *Appl. Microbiol. Biotechnol.* 61, 121–131.

- Suarez M C, Bernal A, Gutierrez J, Tohme J and Fregene M 2000 Developing expressed sequence tags (ESTs) from polymorphic transcript-derived fragments (TDFs) in cassava (*Manihot esculenta* Crantz). *Genome* 43, 62–67.
- Suwasitika I N, Toop T, Irving H R and Gehring C A 2000 *In situ* and *in vitro* binding of natriuretic peptide hormones in *Tradescantia multiflora*. *Plant Biol.* 2, 1–3.
- Taillon-Miller P, Piernot E E and Kwok P-Y 1999 Efficient approach to unique single-nucleotide polymorphism discovery. *Genome Res.* 9, 499–505.
- Tang C, Hinsinger P, Jaillard B, Rengel Z and Drevon J J 2001 Effect of phosphorous deficiency on the growth, symbiotic N₂ fixation and proton release by two bean (*Phaseolus vulgaris*) genotypes. *Agronomie* 21, 683–689.
- Tansley S D and McCouch S R 1997 Seed banks and molecular maps: unlocking genetic potential from the wild. *Science* 277, 1063, 1066.
- Tar'an B, Michaels T E and Pauls K P 2002 Genetic mapping of agronomic traits in common bean (*Phaseolus vulgaris* L.). *Crop Sci.* 42, 544–556.
- Tar'an B, Michaels T E and Pauls K P 2001 Mapping genetic factors affecting the reaction to *Xanthomonas axonopodis* pv. *phaseoli* in *Phaseolus vulgaris* L. under field conditions. *Genome* 44, 1046–1056.
- Teixeira, Sonia Milagros 1990 Bean production in Brazil. *Mich. Dry Bean Digest* 14, 2–9.
- Thompson L U and Zhang L 1991 Phytic acid and minerals: effect on early markers for mammary and colon carcinogenesis. *Carcinogenesis* 12, 2041–2045.
- Thornsberry J M, Goodman M M, Doebley J, Kresovich S, Nielsen D and Buckler E S 2001 Dwarf8 polymorphisms associate with variation in flowering time. *Nature Genet.* 28, 286–289.
- Timmusk S and Wagner G H 1999 The plant-growth-promoting rhizobacterium *Paenibacillus polymyxa* induces changes in *Arabidopsis thaliana* gene expression: a possible connection between biotic and abiotic stress responses. *Mol. Plant-Microb. Int.* 12, 951–959.
- Tsimilli-Michael M, Eggenberg P, Biro B, Köves-Péchy K, Vörös I and Strasser R J 2000 Synergistic and antagonistic effects of arbuscular mycorrhizal fungi and *Azospirillum* and *Rhizobium* nitrogen-fixers on the photosynthetic activity of alfalfa, probed by the polyphasic chlorophyll *a* fluorescence transient O-J-I-P. *Appl. Soil Ecol.* 15, 169–182.
- Vadez V, Lasso J H, Beck D P and Drevon J J 1999 Variability of N₂ fixation in common bean (*Phaseolus vulgaris* L.) under P deficiency is related to P use efficiency. *Euphytica* 106, 231–242.
- Vallad G, Rivkin M, Vallejos C and McClean P 2001 Cloning and homology modeling of a Pto-like protein kinase family of common bean (*Phaseolus vulgaris* L.). *Theor. Appl. Genet.*, 103; 1046–1058.
- Vallejos C E, Sakiyama N S and Chase C D 1992 A molecular marker-based linkage map of *Phaseolus vulgaris* L. *Genetics* 131, 733–740.
- van der Biezen E A, Juwana H, Parker J E and Jones J D 2000 cDNA-AFLP display for the isolation of *Peronospora parasitica* genes expressed during infection in *Arabidopsis thaliana*. *Mol. Plant Microbe Interact.* 13, 895–898.
- Vance C P 1997 Enhanced agricultural sustainability through biological nitrogen fixation. *In* Biological Nitrogen Fixation for Ecology and Sustainable Agriculture. NATO ASI Series, Vol G 39. Eds. A Legocki, H Bothe and A Puhler. pp. 179–186. Springer-Verlag, Berlin, Heidelberg.
- Vanhouten W and MacKenzie S 1999 Construction and characterization of a common bean bacterial artificial chromosome library. *Plant Mol. Biol.* 40, 977–983.
- Vera-Núñez J A, Grageda-Cabrera O A and Peña-Cabriales J J 2000 Metodologías para evaluar la fijación biológica de nitrógeno. *In* La fijación Biológica de Nitrógeno en América Latina, El aporte de las técnicas isotópicas. Ed. J J Peña-Cabriales. pp. 59–67. IMPROSA, Irapuato, Gto. México.
- Vitale A and Bollini R 1995 Legume storage proteins. *In* Seed Development and Germination. Eds J Kiegel and G Galili. pp. 73–102. Marcel Dekker Inc., New York, Basel, Hong Kong.
- Voet M, Defoor E, Verhasselt P, Riles L, Robben J and Volckaert G 1997 The sequence of a nearly unclonable 22.8 kb segment on the left arm of chromosome VII from *Saccharomyces cerevisiae* reveals ARO2, RPL9A, TIP1, MRF1 genes and six new open reading frames. *Yeast* 13, 177–182.
- Volkman D, Baluska F 1999 Actin cytoskeleton in plants: From transport networks to signaling networks. *Microscopy Res. Techn.* 47, 135–154. W. Plant regeneration from embryo derived callus in *Phaseolus vulgaris* L.
- Waines J, Manshardt R and Wells W 1989 Interspecific hybridization between *Phaseolus vulgaris* and *P. acutifolius*. *In* Genetic Resources of *Phaseolus* Beans. Ed. P Gepts. pp. 485–502. Kluwer, Dordrecht.
- Walker K A 1973 Changes in phytic acid and phytase during early development of *Phaseolus vulgaris* L. *Planta* 116, 91–98.
- Wang S-M, Fears S C, Zhang L, Chen J-J and Rowley J D 2000 Screening poly(dA/dT) cDNAs for gene identification. *Proc. Natl. Acad. Sci. USA* 97, 4162–4167.
- Wang X, Wurtele E S and Nikolau B J 1995 Regulation of β -methyl-crotonyl-CoA carboxylase activity by biotinylation of the apoenzyme. *Plant Physiol.* 108, 1133–1139.
- Weaver L M, Yu Fei, Wurtele E S and Nikolau B J 1996 Characterization of the cDNA and gene coding for the biotin synthase of *Aabidopsis thaliana*. *Plant Physiol.* 110, 1021–1028.
- Weeden N F, Muehlbauer F J and Ladizinsky G 1992 Extensive conservation of linkage relationships between pea and lentil genetic maps. *J. Hered.* 83, 123–129.
- Welch R M, House W A, Beebe S and Cheng Z 1995 Genetic selection for Welsh W, Bushuk W, Roca W, Singh S P. Characterization of agronomic traits and markers of recombinant inbred lines from intra- and interracial populations of *Phaseolus vulgaris* L. *Theor. Appl. Genet.* 91, 169–177.
- Welch R M, House W A, Beebe S and Cheng Z 2000 Genetic selection for enhanced bioavailable levels of iron in bean (*Phaseolus vulgaris* L.) seeds. *J. Agr. Fd Chem.* 48, 3576–3580.
- Winzler E A, Shoemaker D D, Astromoff A, Liang H, Anderson K, André B, Bangham R, Benito R, Boeke J D, Bussey H, Chu A M, Connolly C, Davis K, Dietrich F, Whelen Dow S, El Bakkoury M, Foury F, Friend S H, Gentalen E, Giaever G, Hegemann J H, Jones T, Laub M, Liao H, Liebundguth N, Lockhart D J, Lucau-Danila A, Lussier M, M'Rabet N, Menard P, Mittmann M, Pai C, Rebischung C, Revuelta J L, Riles L, Roberts C J, Ross-MacDonald P, Scherens B, Snyder M, Sookhai-Mahadeo S, Storms R K, Véronneau S, Voet M, Volckaert G, Ward T R, Wysocki R, Yen G S, Yu K, Zimmermann K, Philippsen P, Johnston and Davis M, 1999 Functional characterization of the *S. cerevisiae* genome by gene deletion and parallel analysis. *Science* 285, 901–906.
- Wiseman B R 1994 Plant resistance to insects in integrated pest management. *Plant Dis.* 78, 927–932.
- Wiseman B R, Davis F M, Williams W P 1996 Resistance of a maize genotype, Fawcc(C5), to fall armyworm larvae. *Florida Entomologist* 79: 329–336.

- Wortmann C S, Kirkby R A, Eledu C A, Allen D J 1998 Atlas of Common Bean (*Phaseolus vulgaris* L.) Production in Africa. CIAT, Cali, Colombia.
- Xi C, Schoeters E, Vanderleyden J and Michiels J 2000 Symbiosis-specific expression of *Rhizobium etli casA* encoding a secreted calmodulin-related protein. Proc. Natl. Acad. Sci. USA 97, 11114–11119.
- Yan G, Chadee D D and Severson D W 1998 Evidence of genetic hitchhiking effect associated with insecticide resistance in *Aedes aegypti*. Genetics 148, 793–800.
- Young R A, Melotto M, Nodari R O and Kelly J D 1998 Combining classical genetics and molecular markers to characterize the oligogenic anthracnose resistance in the common bean cultivar, G2333. Theor. Appl. Genet. 96, 87–94.
- Yu Z, Stall R, Vallejos C 1998 Detection of genes for resistance to common bacterial blight of beans. Crop Sci. 38, 1290–1296.
- Zagnitko O, Jelenska J, Tevzadze G, Haselkorn R and Gornicki P 2001 An isoleucine/leucine residue in the carboxyltransferase domain of acetyl-CoA carboxylase is critical for interaction with aryloxyphenoxypionate and cyclohexanedione inhibitors. Proc. Natl. Acad. Sci. USA 98, 6617–6622.
- Zambre M A, De Clercq J, Vranova E, Van Montagu M, Angenon G and Dillen W 1998 Plant regeneration from embryo derived callus in *Phaseolus vulgaris* L. (common bean) and *P. acutifolius* A Gray (teparty bean) Plant Cell Rep. 17, 626–630.
- Zambre M, Terryn N, De Clercq J, De Buck S, Dillen W, van Montagu M, Van Der Straeten D and Angenon G (2003) Light strongly promotes gene transfer from *Agrobacterium tumefaciens* to plant cells. Planta 216; 580–586.
- Zambre M A, Geerts P, Maquet A, Van Montagu M, Dillen W and Angenon G 2001 Regeneration of fertile plants from callus in *Phaseolus polyanthus* (year bean). Ann. Bot London 88, 371–377.

Appendix – consortium members

Dr. Jorge A. Acosta-Gallegos, INIFAP
jamk@prodigy.net.mx
Instituto Nacional de Investigaciones Forestales y Agropecuarias, Carretera celaya-San Miguel Allende Km. 6.5. celaya, Gto, Mexico. Fax: +52 461 6115023. Tel: +52 461 6115023.

Prof. Mario O. Aguilar, UNLP,
aguilar@nahuel.biol.unlp.edu.ar
IBBM, Instituto de Bioquímica y Biol. Molecular, Universidad Nacional de La Plata, Calles 47 y 115, 1900 La Plata, Argentina. Fax: +54 221 250 947. Tel: +54 221 250 497.

Prof. Hani Antoun, UL/RVS
Antoun@rsvs.ulaval.ca
Local 1167, R.S.V.S., Pavillon Charles-Eugène Marchand, Université Laval, Québec, Canada G1K 7PQ. Fax: +1 418 656 7176. Tel: +1 418 656 3650 ext. 2131.

Dra. Maria P. Arrieta-Montiel, IBT/UNAM
marrieta@ibt.unam.mx
Instituto de Biotecnología, UNAM, Av. Universidad 2001, Col. Chamilpa, 62210, Cuernavaca, Morelos, México, Fax: +52 77 73 172388. Tel: +52 77 73 291668.

Prof. Craig A Atkins, UWA/P
catkins@cyllene.uwa.edu.au
Department of Botany, University of Western Australia, 35 Stirling Highway, Crawley, WA 6005, Australia. Fax: +61 8 93801001. Tel: +61 8 93802262.

Prof. Jean-Pierre Baudoin, LTCHH/G
baudoin.jp@fsagx.ac.be
Faculté Universitaire des Sciences Agronomiques, Unité de Phytotechnie Tropicale et d'Horticulture, Département 'Agronomie, Economie et Développement', Passage des Déportés, 2, B. 5030 Gembloux, Belgium. Fax: +32 81 614544. Tel: +32 81 622112, <http://www.fsagx.ac.be>.

Dr. Steve Beebe, CIAT
s.beebe@cgiar.org
CIAT – International Center for Tropical Agriculture, A.A. 6713, Cali, Colombia, South America. Fax: +57 2 4450 073, Via USA +1 650 833 6626. Tel: +57 2 4450 000, Via USA +1 650 833 6625. Miami address: CIAT – International Center for Tropical Agriculture, 1380 N.W. 78th Avenue, Miami, Florida 33126, USA. Fax: + 1305 592 9757.

Dr. Matthew W. Blair, CIAT
m.blair@cgiar.org
CIAT – International Center for Tropical Agriculture, A.A. 6713, Cali, Colombia, South America. Fax: +57 2 4450 073, Via USA +1 650 833 6626. Tel: +57 2 4450 000, Via USA +1 650 833 6625. Miami address: CIAT – International Center for Tropical Agriculture, 1380 N.W. 78th Avenue, Miami, Florida 33126, USA. Fax: +1 305 592 9757.

Dr. Dan Bergey, MSU/B
bergeyd@montana.edu
Soil and Environmental Microbiology, Montana State University, PO Box 173 120, Bozeman, MT 59717 3120, USA. Fax: +1 406 994 3933. Tel: +1 406 994 2190.

Dr. Kirstin Bett, CDC/US
k.bett@usask.ca

Department of Plant Sciences, University of Saskatchewan, 51 Campus Drive, Saskatoon, SK, S7N 5A8, Canada. Fax: +1 306 966 5015. Tel: +1 306 966 4947.

Dr. Roberto Bollini, IBBA/CNR

bollini@ibba.cnr.it

Istituto di Biologia e Biotecnologia Agraria, CNR, Via Bassini 15, 20133, Milan, Italy. Fax: +39 022 369 9411. Tel: +39 022 369 9430.

Dr. Graeme Bradley, B/UWC

gbradley@uwc.ac.za

University of the Western Cape, Department of Biotechnology, Private Bag X17, Bellville, 7535, South Africa. Tel: +27 21 959 2199.

Dr. Sonya Broughton, AgWA

smbroughton@agric.wa.gov.au

Crop Improvement Institute/Entomology, Agriculture Western Australia, Baron-Hay Court, South Perth, Western Australia 6151. Fax: +61 8 9474 2840. Tel: +61 8 9368 3271.

Prof. William Broughton, LBMPs,

william.broughton@bioveg.unige.ch

Laboratoire de Biologie Moléculaire des Plantes Supérieures (LBMPs), Université de Genève, 1 ch. de l'Impératrice, 1292 Chambésy/Genève, Switzerland. Fax: +41 22 906 17 41. Tel: +41 22 906 17 40.

Prof. Luis E. A. Camargo, ESALQ/USP

leacamar@esalq.usp.br

Department of Plant Pathology, ESALQ, University of Sao Paulo, Av. Padua Dias, 11 Piracicaba, SP 13418-900, Brazil. Fax: +55 19 3434 4839. Tel: +55 19 3429 4124.

Dr. Bruno Campion, CNR/ISPORT

bruno.campion@libero.it

Istituto Sperimentale per l'Orticultura di Pontecagnano, Salerno, S.O.P. di Montanaso Lombardo, Via Pallese 28, 26836, Montanaso Lombardo, Lodi. Fax: +39 0371 68172. Tel: +39 0371 68171.

Dr. Francisco Campos, IBt/UNAM

campos@ibt.unam.mx

Instituto de Biotecnología, UNAM, Av. Universidad 2001, Col. Chamilpa, 62210, Cuernavaca, Morelos, México. Fax: +52 77 73 172388. Tel: +52 77 73 291668

Dr. Andrea Carboni, PIN

a.carboni@isci.it

ISCI, Istituto Sperimentale per le Colture Industriali, via di Corticella, 133-40128, Bologna, Italy. Fax: +39 51374857. Tel: +39 516316832.

Prof. Gary Cobon, APAF

gcobon@proteome.org.au

Australian Proteome Analysis Facility, Level 4, Building F7B, Macquarie University, Sydney, Australia 2109. Fax: +61 2 9850 6200. Tel: +61 2 9850 6250. Mob: +61 407 299 152.

Dra. Alejandra Covarrubias, IBt/UNAM

crobles@ibt.unam.mx

Instituto de Biotecnología, UNAM, Av. Universidad 2001, Col. Chamilpa, 62210, Cuernavaca, Morelos, México. Fax: +52 77 73 172388. Tel: +52 77 73 291668.

M. C. Sonia Cuellar, IBt/UNAM

scuellar@ibt.unam.mx

Instituto de Biotecnología, UNAM, Av. Universidad 2001, Col. Chamilpa, 62210, Cuernavaca, Morelos, México. Fax: +52 77 73 172388. Tel: +52 77 73 291653, 291666.

Dr. Francis De Lima, AgWa

fdelima@agric.wa.gov.au

Crop Improvement Institute/Entomology, Agriculture Western Australia, Baron-Hay Court, South Perth, WA 6151. Fax: +61 8 9474 2840. Tel: +61 8 9368 3587.

Dr. Antonio M. De Ron, MBG-CSIC,

amderon@mbg.cesga.es

MBG-CSIC, P.O. Box 28, 36080 Pontevedra, Spain. Fax: +34 986 841 362. Tel: +34 986 854 800. Mob: +34 629 824 536. www.usc.es/mevex. phaselieu.cesga.es.

Dr. Jaroslav Dolezel, O/IEB

dolezel@ueb.cas.cz

Laboratory of Molecular Cytogenetics and Cytometry, Institute of Experimental Botany, Academy of Sciences of the Czech Republic, Sokolovska 6, CZ-77200, Olomouc, Czech Republic. Fax: +420 68 5228523. Tel: +420 68 5228521. Web: www.ueb.cas.cz/olomouc1.

Dr. Jean-Jacques Drevon, INRA/M

drevonjj@ensam.inra.fr

ENSA.M-INRA Sol Symbioses Environnement UMR, Place Viala 34060 Montpellier cedex, France. Fax: +33 4 67 54 5708. Tel: +33 4 99 61 2269.

Dr. Hugues Driguez, CERMAV-CNRS
Hugues.Driguez@cermav.cnrs.fr
CNRS-CERMAV, 38041 Grenoble cedex 9, France.
Fax: +33 4 7654 7203. Tel: +33 4 7603 7664.

Dr. Peter Eggenberg, BIOEN/GE
Peter.Eggenberg@bioen.unige.ch
Laboratoire de Bioénergétique, Université de Genève,
Chemin des Embrouchis 10, 1254 Jussy/Genève,
Switzerland. Fax: +41 22 759 99 45. Tel: +41 22 759
99 40.

Prof. Farida H. Shah, MBC/M
shahf2@yahoo.com or faridashah@melaka.gov.my
Melaka Biotechnology Centre, Melaka Biotechno-
logy Division, Ayer Keroh, Melaka, Malaysia. Tel:
606 2307243. Fax: +603 78751399. Mob: +603
123041356.

Dr. Valérie Geffroy, INRA/CNRS/O
geffroy@ibp.u-psud.fr
Laboratoire de Phytopathologie moléculaire (LPPM),
Institut de Biotechnologie des Plantes (IBP), Bâti-
ment 630, Université Paris, Sud, 91 405 Orsay Cedex,
France. Fax: +33 1 69 15 34 24. Tel: +33 1 69 15 33
70 (off).

Prof. Chris A. Gehring, B/UWC
cgehring@uwc.ac.za
University of the Western Cape, Department of Bio-
technology, Private Bag X17, Bellville, 7535, South
Africa. Tel: +27 21 959 2199.

Prof. Paul Gepts, ARS/UC
plgepts@ucdavis.edu
Department of Agronomy and Range Science, Univer-
sity of California, One Shields Avenue, Davis, CA
95616-8515, USA. Tel: +1 530 752 7743 (off). Fax:
+1 530 752 4361.

Prof. Marcelo Guerra, LCV/UFPE
mguerra@npd.ufpe.br
Laboratório de Citogenética Vegetal, Departamento de
Botânica – CCB – UFPE, R. Prof. Moraes Rego, s/n,
CDU, Recife – PE, Brazil 50.670-901. Fax: +55 81
32718350. Tel: +55 81 32718846.

Dr. Gudni Hardarson, IAEA/FAO
G.Hardarson@iaea.org
Soil Science Unit, IAEA Laboratories, A-2444
Seibersdorf, Österreich. Fax: +43 1 26007 28222. Tel:
+43 1 2600 28277.

Prof. Robert Haselkorn, UC/MGCB
r-haselkorn@uchicago.edu
Department of Molecular Genetics and Cell Biology,
University of Chicago, Chicago, IL 60637, USA. Tel:
+1 773 702 1069. Fax: +1 773 702 2853.

Prof. Georgina Hernández, CIFN/UNAM
gina@cifn.unam.mx
Centro de Investigación sobre Fijación de Nitrógeno,
U.N.A.M., Apdo. Postal 565-A, 62210 Cuernavaca,
Mor. México. Fax: +52 77 731 16710. Tel: +52 77 73
139 877.

Prof. Luis Herrera-Estrella, CINVESTAV
lherrera@ira.cinvestav.mx
CINVESTAV, Unidad Irapuato Gto, 36500 Irapuato
Gto, México. Fax: +52 462 6245849. Tel: +52 462
62396 01.

Dr. Mariangela Hungria
hungria@cnpso.embrapa.br
EMPRAPA Soja, Cx. Postal 231, 86001970 Londrina,
Brazil. Fax: +55 433 716 100. Tel: +55 433 716 206.

Dr. Helen R. Irving, VCP/M
helen.irving@vcp.monash.edu.au
Department of Pharmaceutical Biology and Pharma-
cology, Victorian College of Pharmacy, Monash Uni-
versity, 381 Royal Parade, Parkville, Victoria 3052
Australia. Fax: +61 3 9903 9638. Tel: +61 3 9903
9565.

Prof. James D. Kelly, EL/MSU
kellyj@msu.edu
Crop and Soil Sciences, Michigan State University,
East Lansing, MI 48824, USA. Fax: +1 517 353 3955.
Tel: +1 517 355 0205.

Dr. Serge Laberge, AgCAN
laberges@em.agr.ca
Centre de recherche et de développement sur les sols
et les grandes cultures, 2560, bld. Hochelaga, Sainte-
Foy, Québec, Canada G1V 2J3. Fax: +1 418 648 2402.
Tel: +1 418 657 7985.

Dr. Thierry Langin, INRA/CNRS/O
langin@ibp.u-psud.fr
Laboratoire de Phytopathologie moléculaire (LPPM),
Institut de Biotechnologie des Plantes, Bâtiment 630,
91405 Orsay Cedex, France. Fax: +331 69 15 34 24.
Tel: +331 69 15 33 67 (off).

Dr. Miguel Lara, CIFN/UNAM

lara@cifn.unam.mx

Centro de Investigación sobre Fijación de Nitrógeno, U.N.A.M., Apdo. Postal 565-A, 62210 Cuernavaca, Mor. México. Fax: +52 777 3174357. Tel: +52 777 329 1815.

Dr. Lucia Lioi, IG/CNR

lioi@igv.cnr.it

Istituto del Germoplasma, Via Amendola 165/A, 70126, Bari, Italy. Fax: +39 080 558 7566. Tel: +39 080 558 3400 ex. 238.

Dr. Ellen Luyten, CMPG/KUL

ellen.luyten@agr.kuleuven.ac.be

Centrum voor Microbiële en Plantengenetica, Katholieke Universiteit Leuven, Kasteelpark Arenberg 20, B-3001 Heverlee, Belgium. Tel: +32 16 32 16 31. Fax: +32 16 32 19 63.

Dr. Jiri Macas, IPMB/CB

macas@umbr.cas.cz

Institute of Plant Molecular Biology, Department of Molecular Cytogenetics, Academy of Sciences of the Czech Republic, Branišovská 31, 370 05 České Budějovice, Czech Republic. Fax: +420 38 5310356. Tel: +420 38 7775513.

Prof. Phil McClean, NDSU/F

phillipmcclean@ndsu.nodak.edu

Department of Plant Sciences, Loftsgard Hall, North Dakota State University, Fargo, ND 58105, USA. Fax: +1 701 231 8474. Tel: +1 701 231 8443.

Prof. Sally Mackenzie, UN/L

smackenzie2@unl.edu

Beadle Centre for Genetics Research, University of Nebraska, Lincoln, NE 68588-0660, USA. Fax: +1 402 472 3139. Tel: +1 402 472 6997.

Dr. Timothy R. McDermont, MSU/B

timmcderr@montana.edu

Soil and Environmental Microbiology, Montana State University, PO Box 173 120, Bozeman MT 59717-3120, USA. Fax: +1 406 994 3933. Tel: +1 406 994 2190.

Dr. Alain Maquet

alain.maquet@irmm.jrc.be

European Commission, DG Joint Research Centre, Institute for Reference Materials and Measurements, Retiezesweg, B-2440 Geel, Belgium

Dr. Maeli Melotto, ESALQ/USP

mmelotto@esalq.usp.br or melottom@msu.edu

Department of Plant Pathology, ESALQ, University of Sao Paulo, Av. Padua Dias, 11 Piracicaba, SP 13418-900, Brasil.

Prof. Tom Michaels, PA/UG

michaels@uoguelph.ca

Biotechnology Division, Department of Plant Agriculture, University of Guelph, Guelph, Ontario, N1G 2W1, Canada. Fax: +1 519 763 8933.

Dr. Jan Michiels, CMPG/KUL

jan.michiels@agr.kuleuven.ac.be

Centrum voor Microbiële en Plantengenetica, Katholieke Universiteit Leuven, Kasteelpark Arenberg 20, B-3001 Heverlee, Belgium. Tel: +32 16 32 16 31. Fax: +32 16 32 19 63.

Dr. David Henry Moon, CENA/USP

moon@mail.cena.usp.br

Laboratorio de Biologia Celular e Molecular, Universidade de Sao Paulo, Campus de Piracicaba, Centro de Energia Nuclear na Agricultura, Av. Centenario 303, Caixa Postal 96, CEP 13400-970, Piracicaba, Sao Paulo, Brasil. Fax: +55 19 429 4610. Tel: +55 19 429 4600.

Dr. Jeremy Murray, PA/UG/G

jeremymu@uoguelph.ca

Biotechnology Division, Department of Plant Agriculture, University of Guelph, Guelph, Ontario, N1G 2W1, Canada. Fax: +1 519 763 8933.

Dr. Richard O. Musser, UA/T

rmusser@ag.arizona.edu

Center for Insect Science, Department of Plant Science, College of Agriculture and Life Sciences, University of Arizona, Forbes Building # 36 RM 303, PO Box 210036, Tucson, Arizona 85721-0036, USA. Fax: +1 520 621 7186. Tel: +1 520 626 2632.

Prof. Marc van Montagu, IPBO/UG

mamon@gengenp.rug.ac.be

Institute Plant Biotechnology for Developing Countries (IPBO), Department Genetics, K.L. Ledeganckstraat 35, 9000 Gent, Belgium. Fax: +32 9 264 8795. Tel: +32 9 264 8727.

Dr. Jan-Peter Nap, PRI/W

janpeter.nap@wur.nl

BU Genomics, Plant Research International, P.O. Box

16, NL-6700 AA Wageningen, The Netherlands. Fax: +31 317 418094. Tel: +31 317 477169.

Dr Vit Našinec, TESBI/CB
nasinec@thsbp.cas.cz

Technical Services of the Biological Institutes, Academy of Sciences of the Czech Republic, Branisovska 31, 370 05 Ceske Budejovice, Czech Republic. Fax: +420 385 310338. Tel: +420 387 775924.

Prof. Dale Noel
dale.noel@marquette.edu

Department of Biology, Marquette University, Milwaukee, WI 53233, USA. Fax: +1 414 288 7357. Tel: +1 414 288 7355.

Prof. Roberto Papa, PIN
rpapa@unian.it or roberto_papa@yahoo.com
Dipartimento di Biotecnologie Agrarie ed Ambientali, Università Politecnica delle Marche, Via Brecce Bianche, 60131 Ancona, Italy. Fax: +39 712204858. Tel: +39 712204984 (off), +39 712204983 (lab), <http://www.phita.net/> and <http://www.agr.unian.it/>

Prof. K. Peter Pauls, PA/UG/G
ppauls@uoguelph.ca
Biotechnology Division, Department of Plant Agriculture, University of Guelph, Guelph, Ontario, N1G 2W1, Canada. Fax: +1 519 763 8933.

Dr. Andrea Pedrosa, LCV/UFPE
adcpedrosa@uol.com.br
Laboratório de Citogenética Vegetal, Departamento de Botânica – CCB – UFPE, R. Prof. Moraes Rego, s/n, CDU, Recife – PE, Brazil 50.670.901. Fax: +55 81 32718350. Tel: +55 81 32718846.

Prof. Juan-Jose Peña-Cabriales, CINVESTAV
jpena@ira.cinvestav.mx
CINVESTAV, Unidad Irapuato Gto, 36500 Irapuato Gto, México. Fax: +52 462 624 5996. Tel: +52 462 623 9642.

Dr. Xavier Perret, LBMPS/GE
xavier.perret@bioveg.unige.ch
L.B.M.P.S., Université de Genève, 1 ch. de l'Impératrice, 1292 Chambésy/Genève, Switzerland. Fax: +41 22 906 17 41. Tel: +41 22 906 17 48.

Dr. Angela Piergiorganni, IG/CNR
piergiorganni@igv.cnr.it
Istituto del Germoplasma, Via Amendola 165/A,

70126, Bari, Italy. Fax: +39 080 558 7566. Tel: +39 080 558 3400 ext. 214.

Prof. Carmen Quinto, IBt/UNAM
quinto@ibt.unam.mx
Plant Molecular Biology Department, Instituto de Biotecnología, UNAM, Av. Universidad 2001, Chamilpa, Cuernavaca, Morelos, México 62210. Fax: +52 777 313 6600. Tel: +52 777 329 1642.

Dr. Eric Samain, CERMAV-CNRS
eric.samain@cermav.cnrs.fr
BP53, 601 Rue de la Chimie, F-38041 Grenoble cedex 9, France. Fax: +33 4 7654 7203. Tel: +33 4 7603 7603 (central). Tel: 33 4 7603 7648 (direct).

Dr. Federico Sánchez, IBt/UNAM
federico@ibt.unam.mx
Instituto de Biotecnología, UNAM, Av. Universidad 2001, Col. Chamilpa, 62210 Cuernavaca, Morelos, México. Fax: +52 7773 172388. Tel: +52 7773 291653, 291666.

Dr. Marta Santalla, MBG-CSIC
msantalla@mbg.cesga.es
Legumes Breeding Group, MBG-CSIC, P.O. Box 28, 36080 Pontevedra, Spain. Fax: +34 98 6841 362. Tel: +34 98 6854 800. www.usc.es/mevex

Dr. Art Schaafsma, PA/UG/G
aschaafs@ridgetownc.uoguelph.ca
Department of Plant Agriculture, Ridgetown College, University of Guelph, Ridgetown, ON, N0P 2C0 Canada. Fax: +1 519 674 1600.

Dr. Eduardo C. Schröder, UPRM
eschroder5596@yahoo.com
BNF Laboratory, P.O. Box 9030, Department of Agronomy and Soils, University of Puerto Rico, Mayagüez, PR 00681-9030, USA. Fax: +1 787 265 0860. Tel: +1 787 832 3980.

Dr. Andrew J.G. Simpson, LICR
asimpson@ludwig.org.br or
asimpson@ntserver01.ludwig.org.br
Laboratory of Cancer Genetics, Instituto Ludwig de Pesquisa Sobre o Câncer, Rua Prof. Antonio Prudente, 109-4° andar, 01509-010 Liberdade, 01509-101, Sao Paulo, SP Brazil. Fax: +55 11 3207 7001. Tel: +55 11 3207 4922 (ext. 222).

Dr. June Simpson, CINVESTAV
jsimpson@ira.cinvestav.mx
CINVESTAV, Unidad Irapuato Gto, 36500 Irapuato
Gto, México. Fax: +52 462 624 5849. Tel: +52 462
623 9667.

Dr. Francesca Sparvoli, IBBA/CNR
sparvoli@ibba.cnr.it
Istituto di Biologia e Biotecnologia Agraria, CNR,
Via Bassini 15, 20133, Milan, Italy. Fax: +39 022
3699411. Tel: +39 022 3699435.

Dr. Carla Snoeck, CMPG/KUL
Carla.Snoeck@agr.kuleuven.ac.be
Centrum voor Microbiële en Plantengenetica, Kath-
olieke Universiteit Leuven, Kasteelpark Arenberg 20,
B-3001 Heverlee, Belgium. Tel: +32 16 32 16 31. Fax:
+32 16 32 19 63.

Prof. Reto J. Strasser, BIOEN/GE
Reto.Strasser@bioen.unige.ch
Laboratoire de Bioénergétique, Université de Genève,
Chemin des Embrouchis 10, 1254 Jussy/Genève,
Switzerland. Fax: +41 22 759 99 45. Tel: +41 22 759
99 40.

Dr. Wolfgang Streit, UG/G
wstreit@gwdg.de
Institut für Mikrobiologie, Universität Göttingen,
Griesebachstrasse 8, 37077 Göttingen, Deutschland.
Fax: +49 551 393 793. Tel: +49 551 393 775.

Dr. Bunyamin Tar'an, CDC/US
taran@sask.usask.ca
Crop Development Centre, Department of Plant Sci-
ences, University of Saskatchewan, 51 Campus Drive,
Saskatoon, SK, S7N 5A8, Canada. Fax: +1 306 966
5015. Tel: +1 306 966 8586.

Dr. Nancy Terryn, IPBO/UG
nater@gengenp.rug.ac.be
Institute Plant Biotechnology for Developing Coun-
tries (IPBO), Department Genetics, K.L. Ledeganck-
straat 35, 9000 Gent, Belgium. Fax: +32 9 264 8795.
Tel: +32 9 264 5098.

Dr. Joe M. Tohme, CIAT
j.tohme@cgiar.org
Biotechnology Research Unit, Centro Internacional de
Agricultura Tropical, A.A. 6713, Cali, Colombia. Fax:
+57 2 445 0073. Tel: +57 2 445 0000 Ext. 3055/3352.

Dr. S.-M. Tsai, CENA/USP
tsai@cena.usp.br
Dept. Biologia Molecular, CENA/USP, Av. Centen-
ario 303, CP 96 Piracicaba, SP 13416-000, Brasil.
Fax: +19 429 4610. Tel: +19 429 4600.

Prof. Eric W. Triplett, UM/W
triplett@facstaff.wisc.edu
University of Wisconsin-Madison, Department of Ag-
ronomy, 1575 Linden Drive, Madison, WI 53706,
USA. Fax: +1 608 262 5217. Tel: +1 608 262 9824
(office), +1 608 824 0566 (home).

Prof. Albert Vandenberg, CDC/US
bert.vandenberg@usask.ca
Crop Development Centre, Department of Plant Sci-
ences, University of Saskatchewan, 51 Campus Drive,
Saskatoon, SK, S7N 5A8, Canada. Fax: +1 306 966
5015. Tel: +1 306 966 8786.

Prof. Jos Vanderleyden, CMPG/KUL
jozef.vanderleyden@agr.kuleuven.ac.be
Centrum voor Microbiële en Plantengenetica, Kath-
olieke Universiteit Leuven, Kasteelpark Arenberg 20,
B-3001 Heverlee, Belgium. Fax: +32 16 32 19 63, Tel:
+32 16 32 16 31.

Dr. André Vettore, LICR
avettore@ludwig.org.br
Laboratory of Cancer Genetics, Instituto Ludwig de
Pesquisa Sobre o Câncer, Rua Prof. Antonio Prudente,
109-4º andar, 01509-010 Liberdade, 01509-101, São
Paulo, SP Brazil. Fax: +55 11 3207 7001. Tel: +55 11
3207 4922.

Prof. Guido Volckaert, LoGT/UL
Guido.Volckaert@agr.kuleuven.ac.be
Laboratory of Gene Technology, Katholieke Uni-
versiteit Leuven. Kasteelpark Arenberg 21, B-3001
Leuven, Belgium. Fax: +32 1632 1965. Tel: +32 1632
9667.