



Article scientifique

Article

1997

Published version

Open Access

This is the published version of the publication, made available in accordance with the publisher's policy.

---

## Ulnaless (UI), a regulatory mutation inducing both loss-of-function and gain-of-function of posterior Hoxd genes

---

Herault, Yann; Fraudeau-Perrenot, Nadine; Zakany, Jozsef; Duboule, Denis

### How to cite

HERAULT, Yann et al. Ulnaless (UI), a regulatory mutation inducing both loss-of-function and gain-of-function of posterior Hoxd genes. In: Development, 1997, vol. 124, n° 18, p. 3493–3500. doi: 10.1242/dev.124.18.3493

This publication URL: <https://archive-ouverte.unige.ch/unige:84809>

Publication DOI: [10.1242/dev.124.18.3493](https://doi.org/10.1242/dev.124.18.3493)

## ***Ulnaless (UI)*, a regulatory mutation inducing both loss-of-function and gain-of-function of posterior *Hoxd* genes**

Yann Héroult, Nadine Fraudeau, József Zákány and Denis Duboule\*

Department of Zoology and Animal Biology, University of Geneva, Sciences III, Quai Ernest Ansermet 30, 1211 Geneva 4, Switzerland

\*Author for correspondence (e-mail: Duboule@sc2a.unige.CH)

### **SUMMARY**

*Ulnaless (UI)*, an X-ray-induced dominant mutation in mice, severely disrupts development of forearms and forelegs. The mutation maps on chromosome 2, tightly linked to the *HoxD* complex, a cluster of regulatory genes required for proper morphogenesis. In particular, 5'-located (posterior) *Hoxd* genes are involved in limb development and combined mutations within these genes result in severe alterations in appendicular skeleton. We have used several engineered alleles of the *HoxD* complex to

genetically assess the potential linkage between these two loci. We present evidence indicating that *Ulnaless* is allelic to *Hoxd* genes. Important modifications in the expression patterns of the posterior *Hoxd-12* and *Hoxd-13* genes at the *UI* locus suggest that *UI* is a regulatory mutation that interferes with a control mechanism shared by multiple genes to coordinate *Hoxd* function during limb morphogenesis.

Key words: *Ulnaless*, mouse, limb development, *HoxD*

### **INTRODUCTION**

In mice, naturally occurring, or randomly induced, mutations have been an invaluable source of information in the field of developmental genetics. While the ES cell-based approach allows the straightforward inactivation of a given gene, complex mutations such as deletions or rearrangements often illuminate pathogenic mechanisms and developmental regulatory processes of unexpected significance which would have otherwise escaped examination. There are many reported cases in vertebrates where spontaneous mutations did not lead to complete inactivation of a given gene, but rather produced more subtle changes, either in the product of the gene or in its regulation. With respect to limb development, valuable information has been gained from molecular studies of murine mutations such as *limb deformity (ld)* or *Hypodactyly (Hd)* (Kuhlman and Niswander, 1997; Haramis et al., 1995; Chan et al., 1995; Mortlock et al., 1996). Likewise, the molecular characterization of human syndromes affecting limbs, such as the Crouzon, SPD or hand-foot-genital syndromes, combined with knowledge acquired on the murine system, has led to further advances in our understanding of limb morphogenesis (Muenke and Schell, 1995; Yamaguchi and Rossant, 1995; Mortlock and Innis, 1997; Muragaki et al., 1996).

The mouse *Ulnaless (UI)* mutation was generated some thirty years ago by X-ray irradiation (Morris, 1967). It is a dominant mutation affecting mostly the zeugopod (the intermediate piece of the limbs, forearms and forelegs). In *UI/+* animals, both radius and ulna in the forelimb, or tibia and fibula in the hindlimb, are strongly defective. Length reductions are accompanied by severe distal malformations (Davisson and

Cattanach, 1990). The ill-formed articulations in the carpus and tarsus lead to deflected positions of the autopods (hands and feet). No obvious defects are detected in the trunk of these heterozygous animals. Due to these severe alterations of the limbs, *UI/+* males have great difficulties in breeding and homozygous animals could not be obtained by natural matings on the original genetic background. The *Ulnaless* mutation was mapped genetically to mouse chromosome 2 (Davisson and Cattanach, 1990), at the vicinity of the *HoxD* complex, a locus containing several genes of importance for limb development (Dollé and Duboule, 1989).

The *HoxD* complex was mapped to mouse chromosome 2D (Featherstone et al., 1988) and comprises a minimum of eight *Hoxd* genes that are known to play important functions in the organization of the body plan. In particular, the *Hoxd-9* to *Hoxd-13* genes, located at the 5' extremity of the complex and related in sequence to the *Drosophila* gene *AbdB* (Izpisua-Belmonte et al., 1991), are essential for proper patterning and development of the limbs, the genitalia and the posterior vertebral column (Dollé et al., 1993; Fromental-Ramain et al., 1996a; Favier et al., 1995; Davis and Capocchi, 1994, 1996; Kondo et al., 1996). With respect to limb development, *Hoxd* gene knock-outs have revealed their important roles in the growth of both prechondrogenic condensations (Dollé et al., 1993) and bony elements (Davis et al., 1995; Zákány and Duboule, 1996). During limb development, *Hoxd* genes cooperate with posterior genes from the *HoxA* complex so that combined inactivations of paralogous members of both complexes lead to very strong phenotypic alterations. While removing the functions of group 13 genes simultaneously (*Hoxd-13*; *Hoxa-13*) prevents digit formation (Fromental-

Ramain et al., 1996b), mice lacking both *Hoxa-11* and *Hoxd-11* functions have short and abnormal zeugopods (Davis et al., 1995). The fact that this latter phenotype is clearly reminiscent of the *Ul*<sup>+</sup> mutation further supports the involvement of *Hoxd* genes in this abnormal process. In addition, Peichel et al. (1996) recently reported an extensive set of mapping data showing no recombination between the *Ulnaless* mutation and either extremities of the *HoxD* complex, strengthening the hypothesis that this mutation affects one or several member(s) of this complex. However, the molecular nature of the mutation and the actual involvement of *Hoxd* genes in the generation of the phenotype remained to be established.

By using the *Ul* chromosome as well as a variety of different *HoxD* alleles in a genetic approach, we show that the *Ulnaless* mutation affects the regulation of 5'-located *Hoxd* genes in a complex manner. Expression of *Hoxd-13* and *Hoxd-12* in limbs and genitalia of *Ul* animals is perturbed, showing concomitant loss-of-function in digits and ectopic gain-of-function in the zeugopods. We conclude that *Ul* is allelic to the *HoxD* complex and propose that the mutation affects an important regulatory element acting upon several *Hoxd* genes at once. Furthermore, the *Ul* gain-of-function phenotype lends further support to the proposal that a functional hierarchy exists amongst *Hox* proteins.

## MATERIALS AND METHODS

### Mutant lines

The *Ulnaless* mutant line was obtained from the Jackson laboratory (Bar Harbour, Maine), in a B6EiC3H background. The *Hoxd-13<sup>St</sup>* line is a null allele of the *Hoxd-13* gene, produced by insertion of a selection cassette within the homeobox (Dollé et al., 1993). The *Hoxd<sup>Del</sup>* allele is a triple loss-of-function of *Hoxd-13*, *Hoxd-12* and *Hoxd-11*, due to a deletion of the *Hoxd-13* to *Hoxd-12* genomic locus, plus an insertion of the *lacZ* reporter gene within the *Hoxd-11* gene (Zákány and Duboule, 1996). The *HoxD<sup>RX1</sup>* mutation is a small deletion located between *Hoxd-13* and *Hoxd-12* (Y. H. and D. D., unpublished). These chromosomes are depicted in Fig. 1 and were maintained in a C57Bl/6j×129Sv mixed genetic background. The *TgH[d11/lac]<sup>Ge</sup>* mice were produced by transposing a *Hoxd-11/lacZ* reporter transgene upstream of *Hoxd-13* (van der Hoeven et al., 1996).

### Skeletal analysis and whole-mount in situ hybridizations

For skeletal analysis, adult mice were killed, processed and stained with alizarin red S as previously described (Dollé et al., 1993). Mice were derived from crosses between *Ul*<sup>+</sup> females and males heterozygotes for either the *Hoxd-13<sup>St</sup>* or the *HoxD<sup>Del</sup>* mutant alleles. The *Hoxd-13*, *Hoxd-12*, *Hoxd-11* and *Hoxd-10* probes used in whole-mount in situ hybridizations were as described previously (Dollé et al., 1991a,b; Gérard et al., 1996) and labelled with digoxigenin-11-UTP (Boehringer). Embryos were fixed overnight in 4% paraformaldehyde and hybridizations were performed according to established procedure. The staining was carried out using an alkaline-phosphatase-conjugated anti-digoxigenin antibody.

## RESULTS

### *Ulnaless* is a hypomorphic allele of posterior *Hoxd* genes

The dominant phenotype of mice heterozygous for the *Ulnaless* mutation was originally described in Davisson and

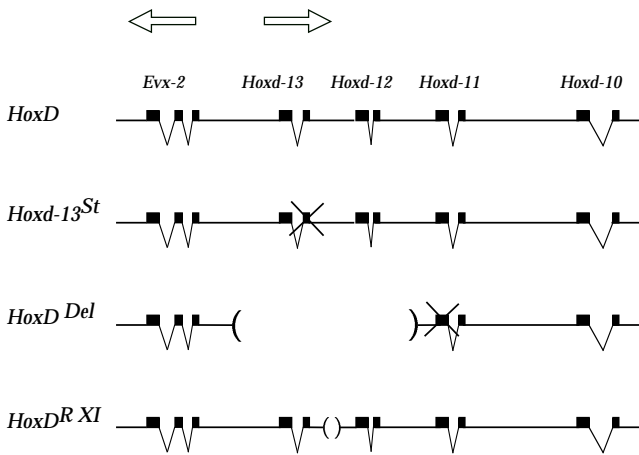
Cattanach, (1990; see also Peichel et al., 1996). Briefly, the zeugopods are strongly reduced in length and characteristically ill formed (Fig. 2A). In particular, the ulna, radius, tibia and fibula are severely affected. Minor but significant defects were also observed in the shape of the humerus (Fig. 2A). Homozygous animals display the same although somewhat more severe defect (Peichel et al., 1996). In contrast, no obvious alteration was found in either the skull or the axial skeleton. We observed the same set of defects on the C57Bl/6j×129Sv genetic background, with no apparent change either in expressivity or in penetrance.

The hands of *Ul*<sup>+</sup> animals did not display major alterations in the number and organisation of digits. However, while mice lacking one dose of *Hoxd-13* (*Hoxd-13<sup>St/+</sup>*) have close-to-normal hands, mice with the *Ul* chromosome over the *Hoxd-13<sup>St</sup>* allele showed well-defined and severe alterations of the digits (Fig. 2B), similar to that expected from a loss-of-function of posterior *Hoxd* genes. The second phalanges of digits II and V were reduced or absent, digit I was ill formed, whereas digits III and IV were normal in appearance. This phenotype was further enhanced in mice lacking one functional complement of *Hoxd-13*, *Hoxd-12* and *Hoxd-11* (*Ul/HoxD<sup>Del</sup>*; Fig. 2B), with an overall stiffer appearance of the hand skeleton. In both cases, the increase in the severity of digit defects observed whenever the *Ul* chromosome was introduced, was similar to that of stronger *Hoxd*-related phenotypes. When the *Ul* mutation was combined with *Hoxd* alleles, it behaved as a *Hoxd-13* hypomorphic allele. This observation was best illustrated with the help of an abnormally prominent bony mass, located on the metatarsal bone of hindlimb digit I, and which was first observed in *Hoxd-13<sup>St/St</sup>* mutant animals (Dollé et al., 1993). While this defect was not detected either in *Ul*<sup>+</sup> animals, or in *Hoxd-13<sup>St/+</sup>* or *HoxD<sup>Del/+</sup>* specimens (e.g. Fig. 2C), *Ul/Hoxd-13<sup>St</sup>* as well as *Ul/HoxD<sup>Del</sup>* exhibited this *Hoxd-13*-specific deformation of digit I (Fig. 2D). Altogether, *Hoxd-13* function in digits was altered by the *Ul* mutation in a way demonstrating that the *Ul* chromosome carried a hypomorphic *Hoxd-13* mutation. No alteration was observed in the vertebral column, even in *Ul/HoxD<sup>Del</sup>* animals, indicating that no substantial loss-of-function of posterior *Hoxd* genes had occurred in the trunk of *Ul* mutant mice (not shown). In the presence of the *HoxD<sup>Del</sup>* allele indeed, such loss-of-function would induce transformations in the lumbosacral region (Zákány et al., 1997).

Extensive mapping of the posterior *HoxD* complex with a battery of probes failed to detect any genomic rearrangement that could explain this phenotype (Peichel et al., 1996; our unpublished work; see also the accompanying paper by Peichel et al., 1997). Likewise, PCR amplification of selected regions did not reveal the molecular nature of the *Ul* mutation. In this latter case, DNA was amplified from *Ul/HoxD<sup>Del</sup>* animals so that DNA sequences localised within the deficiency could only derive from the *Ul* chromosome (see Fig. 3). Significantly, among other DNA stretches, the *Hoxd-13* coding sequence was found unaffected in *Ulnaless* (not shown).

### *Hoxd* genes expression at the *Ulnaless* locus

The difficulty in obtaining *Ul/Ul* homozygous embryos in our genetic background prevented us from looking at *Hoxd* gene expression in absence of wild-type copies. To circumvent this problem, we produced *Ul/HoxD<sup>Del</sup>* embryos in which the *Ul*



**Fig. 1.** Different alleles from the *HoxD* complex used in this work. The wild-type *HoxD* complex is shown on the top line, from *Evx-2* to *Hoxd-10*. The second line corresponds to the *Hoxd-13<sup>St</sup>* allele, an insertional mutation within *Hoxd-13*. The third allele (*HoxD<sup>Del</sup>*) is a large deletion covering from *Hoxd-13* to *Hoxd-12* plus a null mutation within *Hoxd-11*. The fourth allele (bottom) is a microdeletion between *Hoxd-13* and *Hoxd-12*.

chromosome was brought over the *HoxD<sup>Del</sup>* deficiency. These animals were hemizygous for *Hoxd-13* and *Hoxd-12* present on the *Ul* chromosome. We could thus examine the expression pattern of *Ulnaless Hoxd-13* and *Hoxd-12* in the absence of their normal complements. In order to identify embryos of the appropriate genotypes, we crossed *Ul/Hoxd-13<sup>St</sup>* females with males heterozygous for two additional alleles of the *HoxD* complex; *HoxD<sup>Del</sup>* and *HoxD<sup>RXI</sup>*, this latter one being a small deletion between *Hoxd-13* and *Hoxd-12* (Y.H., J. Beckers and D.D., unpublished). Therefore, all chromosomes were labelled and could be identified either by Southern blotting or PCR analysis, the *Ulnaless* chromosome behaving as a wild-type complement using these markers (see Fig. 3).

Whole-mount in situ hybridizations using the *Hoxd-13* probe revealed a strikingly abnormal transcript distribution in such *Ul/HoxD<sup>Del</sup>* fetuses, even though strong signals were detected in the four developing limbs (Fig. 4A). In addition, the expected robust expression in the genital eminence (Dollé et al., 1991) was hardly, if at all, detected in *Ul* mutant animals (Fig. 4B). A closer examination of both forelimbs and hindlimbs (Fig. 4C,D; respectively) clearly defined two distinct types of alterations in *Hoxd-13* expression. Firstly, a substantial decrease in transcript accumulation was observed over the tips of developing digits (Fig. 4C,D; white arrowheads). However, this decrease was not uniform throughout all digits because clear signals were recovered in the primordium of digits III and IV (Fig. 4C; white arrow). Secondly, a strong ectopic domain was detected proximal to the normal *Hoxd-13* expression domain (Fig. 4C,D; black arrowheads). This ectopic patch of expression extended from the proximal future carpus over the entire zeugopods, with a pronounced posterior tendency. The combination of these two traits gave rise to a novel *Hoxd-13* expression pattern, resulting from a concomitant loss-of-function in digits and gain-of-function in zeugopods (e.g. Fig. 4D, right panel).

The analysis of *Hoxd-12* expression in the same genetic configuration gave a similar picture. While *Ul/+* animals already showed a gain-of-function in the zeugopods that overlapped with that of *Hoxd-13* (Fig. 4E; black arrowheads), the removal of the wild-type copy of *Hoxd-12* (*Ul/HoxD<sup>Del</sup>*) indicated that a loss-of-function had occurred in digits (white arrowhead). However, as for *Hoxd-13*, this decrease in *Hoxd-12* transcript accumulation was not complete and primarily concerned digits II and V. Furthermore, an additional ectopic domain was detected more proximal, in the presumptive stylopods (Fig. 4E; short arrowheads), a domain that overlapped the expression domains of more anterior *Hoxd* genes (see Fig. 5). Altogether, these ectopic *Hoxd-13* and *Hoxd-12* expression domains perfectly matched the presumptive areas where the *Ul* mutation generates abnormal skeletal development, i.e. a hypomorphic *Hoxd-13* recessive phenotype in the digits, with a preference for digits II and V, together with a fully penetrant dominant phenotype in the zeugopods. Other minor traits such as e.g. the fusion of small bones in the carpus were scored and were also correlated with the ectopic expression of either *Hoxd-13* or *Hoxd-12*.

Since the combined loss-of-functions of group 11 genes affect the zeugopod (Davis et al., 1995) and because *Hoxd-10* is also expressed there, the transcript domains of *Hoxd-11* and *Hoxd-10* were also analysed in the *Ulnaless* mice. Expression of *Hoxd-11* in *Ul/+* limbs was found close to normal (Fig. 5A, left), with perhaps a slight down-regulation. A similar expression was observed in *Ul/HoxD<sup>Del</sup>* animals (Fig. 5A, right), which are unable to produce a functional *Hoxd-11* protein from the *HoxD<sup>Del</sup>* chromosome (Zákány and Duboule, 1996). Expression of *Hoxd-10* in *Ul/HoxD<sup>Del</sup>* fetal limbs, which thus contain at least one functional copy of the gene, was undistinguishable from that seen in control mice (Fig. 5B, compare left and right panels). In both cases, however, the detection of RNAs transcribed from the *HoxD<sup>Del</sup>* chromosome may have obscured the detection of a slight partial loss-of-function. These experiments nevertheless demonstrated that a large amount of both *Hoxd-11* and *Hoxd-10* transcripts were present in developing *Ul/+* limbs.

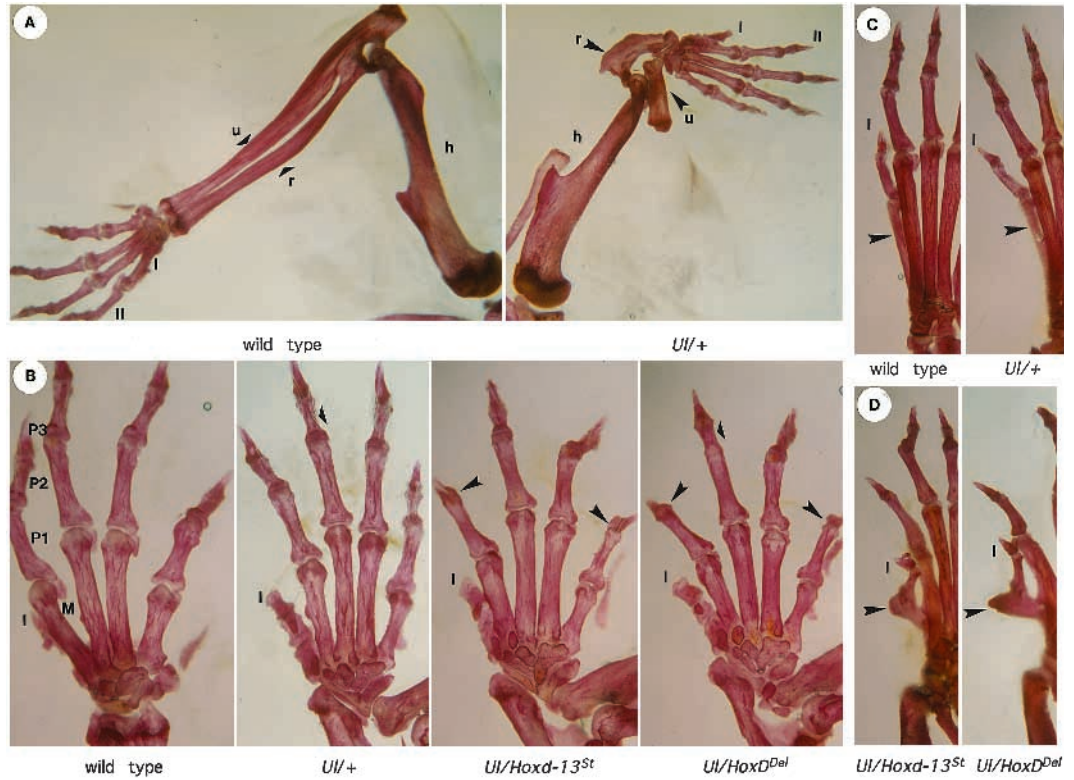
## DISCUSSION

### Is *Ulnaless* allelic to *HoxD*?

Three sets of evidence strongly suggest that the *Ulnaless* mutation is allelic to the *HoxD* complex: (1) the absence of recombination between the two loci, which places them within an approx. 250 kb interval, i.e. an interval only slightly larger than the *HoxD* complex itself (Peichel et al., 1996); (2) the recessive digit phenotypic alterations in *Ul* mice, revealed in complementation studies with loss-of-function alleles of *Hoxd* genes and (3) the clear ectopic expression of two members of the posterior *HoxD* complex, when present on the *Ulnaless* chromosome.

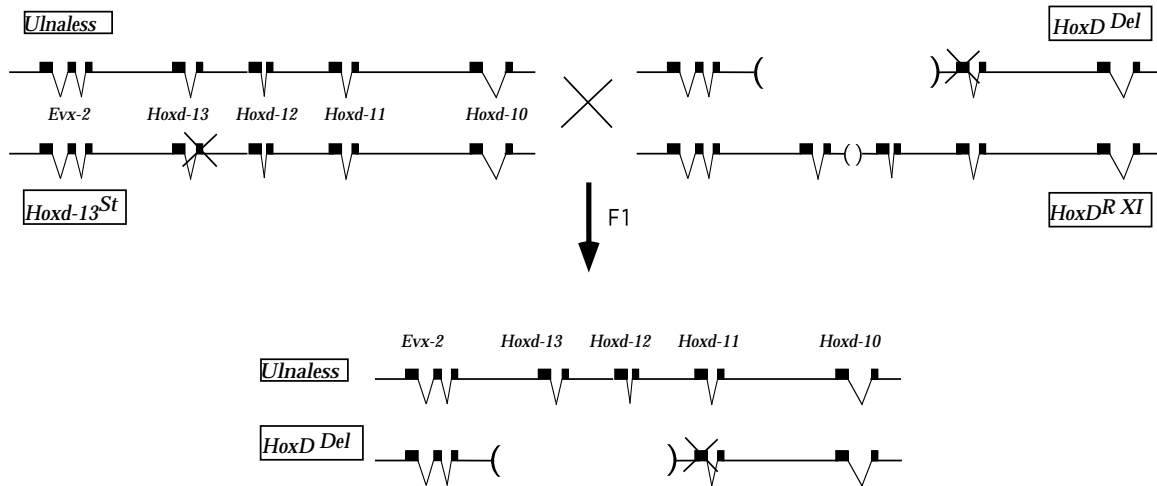
Crosses involving the *Ul* locus as well as several *HoxD* alleles, previously produced through the ES cell technology, revealed that *Ulnaless* mice have a clear hypomorph *Hoxd-13* function. This was most evident when looking at hindlimb digit I of transheterozygous *Ul/Hoxd-13* mice, which unambiguously showed an alteration detected only in other *Hoxd-13* mutant alleles (Dollé et al., 1993; Zákány and Duboule, 1996). This

**Fig. 2.** Skeletal preparations of adult limbs.  
 (A) Comparison between a wild-type (left) and *Ulnaless* (right) arm. Strong reductions and malformations are observed in both radius and ulna of the *Ulnaless* limb (arrowheads). In the left panel, the thumb (digit I) is hidden behind digit II. (B) Hands of *Ulnaless* mice when combined with various *HoxD* alleles. Wild-type and *Ulnaless* hands look essentially normal whereas *Ulnaless/Hoxd-13<sup>St</sup>* and *Ulnaless/HoxD<sup>Del</sup>* hands have reduced or absent second phalanges on digits II and V (arrowheads), thus resembling a hypomorphic *Hoxd-13<sup>St</sup>* phenotype. Size reduction of the P2 in digit III is also visible in *Ulnaless/HoxD<sup>Del</sup>* limb animals (small black arrowheads, compare with *Ulnaless*). (C,D) Bone staining of feet from animals of similar genotypes. In *Ulnaless/Hoxd-13<sup>St</sup>* and *Ulnaless/HoxD<sup>Del</sup>* specimen (D), a specific deformation of digit I (arrowheads) is observed which is identical to that observed in *Hoxd-13<sup>St/St</sup>* animals (Dollé et al., 1993). Moreover the P2 of digit II is absent in *Ulnaless/Hoxd-13<sup>St</sup>* and *Ulnaless/HoxD<sup>Del</sup>* mutant feet. These defects are nevertheless not seen in *Ulnaless* littermates. u, ulna; r, radius; h, humerus; I, II refer to digit number (from thumb to minimus); M, metacarpus; P1 to P3 are phalanges.



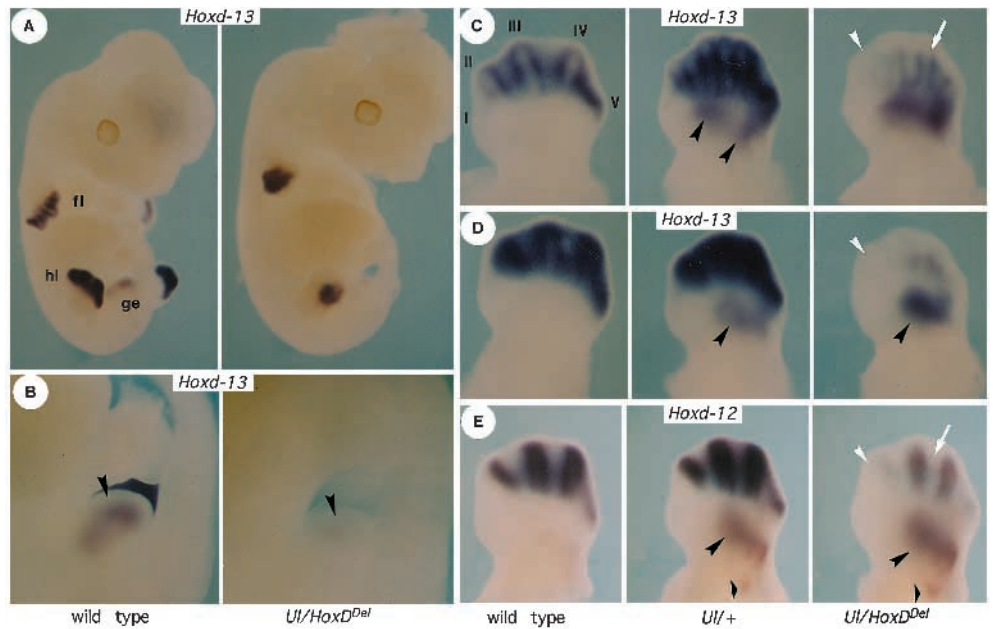
was subsequently confirmed by in situ hybridizations showing that a decrease in both *Hoxd-13* and *Hoxd-12* expression had occurred in the most distal and anterior domains of the autopods. Expression was nevertheless detectable in digits III and IV, i.e. in those digits that have the strongest expression of

these genes in wild-type fetuses (unpublished). We thus conclude that the partial loss-of-function affects the entire distal expression domain, but is less visible in its central part. The fact that some expression was left in digits is also consistent with the phenotype observed in homozygous *Ulnaless*



**Fig. 3.** Crosses used for whole-mount in situ hybridizations. The *Ulnaless* chromosome was segregated together with three differently labelled chromosomes. Phenotypic alterations and/or molecular typing allowed for an easy recovery of those F1 fetuses with the *Ulnaless/Hoxd<sup>Del</sup>* genotype. In these embryos, wild-type *Hoxd-13* and *Hoxd-12* are absent so that in situ hybridization with these probes reveal the hemizygous activity of the two genes from the *Ulnaless* chromosome exclusively.

**Fig. 4.** Whole-mount in situ hybridizations of *Hoxd-13* and *Hoxd-12* from the *Ulnaless* chromosome. (A) Comparison of wild-type (left) and *Ul/Hox<sup>Del</sup>* (right) 11.5-day-old fetuses. *Hoxd-13* transcripts are produced in both cases but with different distributions in the limbs and genitalia. (B) Magnification of the external genital area of the same two animals showing the distal expression of *Hoxd-13* in the genital eminence and the very weak signal obtained from the *Ul* chromosome. (C,D) Loss- and gain-of-function of *Hoxd-13* in developing forelimbs (C) and hindlimbs (D) of *Ul* animals. The gain-of-function in the zeugopod is already clearly visible on the *Ul/+* genotype (black arrowheads) whereas the loss-of-function of this gene in the presumptive digit area (white arrowheads) can only be seen in absence of the wild-type copy, in both hands (C) and feet (D). This loss-of-function affects primarily anterior digits and residual expression can be seen in posterior digits (white arrows in C and E). (E) The expression of *Hoxd-12* in the same genotypes reveals similar alterations in the pattern, namely a down-regulation of expression in anterior digits (white arrowhead) as well as a strong ectopic domain in the zeugopod (black arrowheads). In addition, a small but consistent ectopic domain was found in the stylopod as well (small black arrowheads).



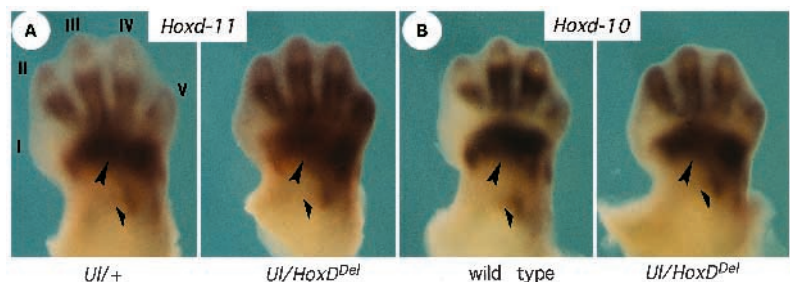
animals (Peichel et al., 1996), as such mice have a digit phenotype weaker than that of complete *Hoxd-13* loss-of-function (Dollé et al., 1993).

The concomitant down-regulation of several *Hoxd* genes indicates, however, that the *Ul* mutation may not be allelic to one particular gene. Instead, the mutation may affect a supra-genic mechanism that controls the expression in digits of many genes at once. This is in agreement with the proposal that a unique enhancer element might be responsible for the expression of posterior *Hoxd* genes in presumptive digits (van der Hoeven et al., 1996). In this view, the *Ul* mutation would be identified as a regulatory mutation and would thus be allelic to an extended part of the *HoxD* complex as it would interfere with a shared multigenic control mechanism. Interestingly, this putative mechanism was proposed to be involved in the development of the genital eminence as well, due to the co-expression of the same *Hoxd* genes in both genital and distal limb buds in various transgenic configurations (van der Hoeven et al., 1996). This proposal gains further support after examination of *Ulnaless* mice, since expression was importantly down-regulated in digits and genital eminence, simultaneously. Accordingly, penian bones (baculum) of *Ul/HoxD<sup>Del</sup>* mice were significantly smaller than those of wild-type mice (not shown), further suggesting that digits and external genitalia may share some important regulatory controls.

***Hoxd-13* gain-of-function**

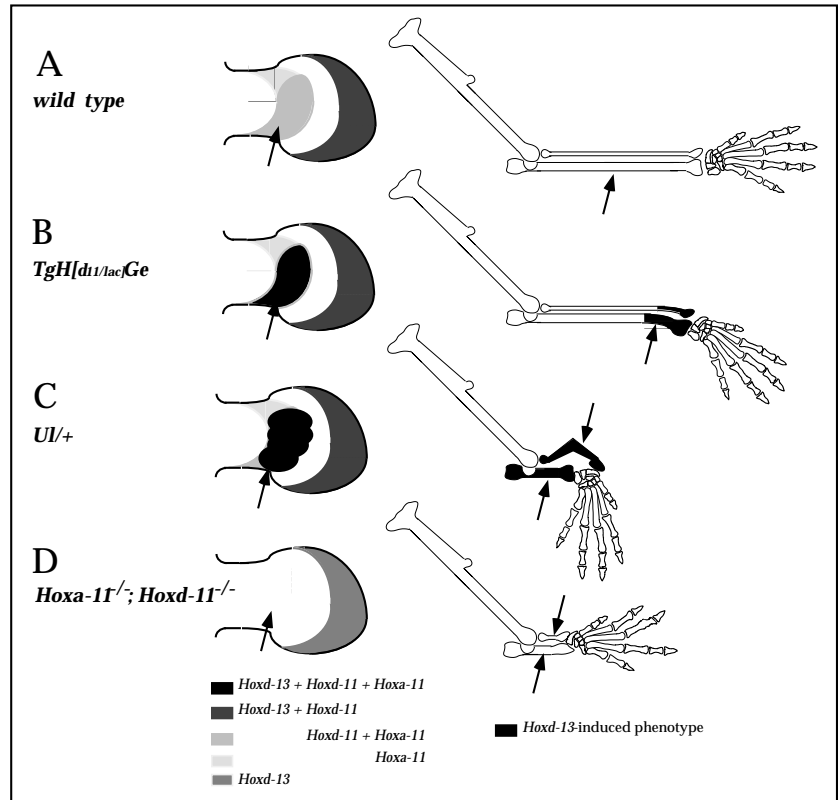
The most dramatic feature of *Ul* mice was the extreme reduction of their zeugopods which thus resembled those obtained when removing both

*Hoxd-11* and *Hoxa-11* functions (Davis et al., 1995). Upon in situ analyses, a correlation was established between the *Ul*-induced defect and ectopic expression of *Hoxd-13/Hoxd-12* in presumptive zeugopods (Fig. 6C, arrows), suggesting that a causal relationship may exist between a *Hoxd-13/Hoxd-12* gain-of-function on the one hand, and a global *Hox* group 11 loss-of-function (Fig. 6C,D), on the other hand. Interestingly, such a correspondence had previously been noticed in a different context, i.e. when a *Hoxd-11* transgene was transposed next to *Hoxd-13* (the *TgH[d11/lac]<sup>Ge</sup>* mice; van der Hoeven et al., 1996). In such a transposition, the *Hoxd-11* transgene was able to up-regulate *Hoxd-13* in an ectopic

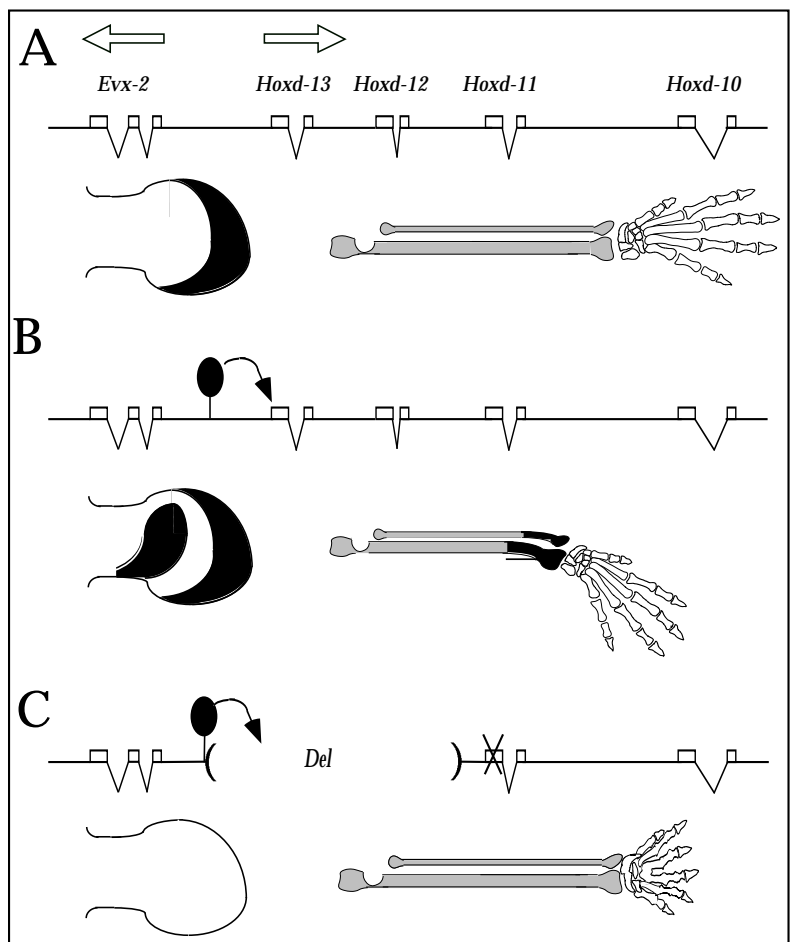


**Fig. 5.** Whole-mount in situ hybridizations of *Hoxd-11* (A) and *Hoxd-10* (B) on E11.5 fetal forelimbs of different genotypes. (A) *Hoxd-11* probe hybridized to either *Ul/+* (left) or *Ul/Hox<sup>Del</sup>* (right). A robust expression of *Hoxd-11* is still observed in both digit and zeugopod domains (large arrowhead). (B) *Hoxd-10* probe hybridized with either wild-type (left) or *Ul/Hox<sup>Del</sup>* (right) embryos. Expression patterns are rather comparable between the two genotypes. In all cases, a more proximal expression domain is detected (small arrowhead), which is identical to the ectopic domain seen with *Hoxd-12* in *Ul* mutant limbs (see Fig. 4E, same arrowhead). This domain is part of the wild-type *Hoxd-10* expression pattern (left panel in B). I to V refer to digit number, from anterior to posterior.

**Fig. 6.** Schematic representation of the relationship between *Hoxd-13* gain-of-function in either the *TgH[d11/lacGe]* (B) or *U1* mice (C) and the phenotypic alterations of the zeugopod bones (right column, in black), and comparison with the wild-type (A) or *Hox* group 11 loss-of-function phenotype (D). Wherever *Hoxd-13* is ectopically expressed, a truncation of the zeugopod is observed which resembles that seen when removing multiple *Hox* group 11 doses, thus suggesting that ectopic *Hoxd-13* antagonizes group 11 functions (see the Discussion).



**Fig. 7.** Scheme illustrating that ectopic *Hoxd-13* is indeed responsible for the *zeugopod* phenotype (A). In presence of *Hoxd-13*, the insertion of the *Hoxd-11/lacZ* transgene upstream of *Hoxd-13* leads to ectopic expression and truncation of the ulna (B). If *Hoxd-13* is removed from this chromosome (C), the truncation is lost and the ulna is back to a wild-type morphology, even though both copies of *Hoxd-11* are inactivated.



expression domain located within the area of group 11 gene zeugopod domain (Fig. 6B, black domain). In this case, ectopic HOXD-13 protein led to truncation of the distal part of the ulna (Fig. 6B, arrows). There is therefore a robust correlation between the extents of *Hoxd-13* ectopic expression domains in both *TgH[d11/lac]<sup>Ge</sup>* and *Ulnaless* mice and the localization and importance of the defects observed in the respective zeugopods (Fig. 6B,C). This strongly suggests that both phenotypes derive from a *Hoxd-13* gain-of-function which, in turn, induces a phenocopy of group 11 loss-of-function phenotypes. Furthermore, group 13 *Hox* gain-of-function approaches in chick have led to similar phenotypic alterations (Goff and Tabin, 1997; Yokouchi et al., 1995).

Another evidence indicating that a *Ul*-related zeugopod phenotype could derive from the misexpression of *Hoxd-13* was obtained when the *Hoxd-13* function was further removed from the *TgH[d11/lac]<sup>Ge</sup>* chromosome (Fig. 7), through a targeted deletion that thus eliminated both normal and ectopic *Hoxd-13* expression domains (Zákány and Duboule, 1996; Fig. 7C; arrow). In the original allele, the *Hoxd-11* transgene induced an up-regulation of *Hoxd-13* in the forearm (arrow) leading to an ectopic domain and concomitant alteration of the ulna (Fig. 7; black dot between *Evx-2* and *Hoxd-13*). However, when *Hoxd-13* was removed, a rescue was observed in the ulna, even though the transgene insertion was still there (data not shown). This result unequivocally demonstrated that the ulna phenotype scored in *TgH[d11/lac]<sup>Ge</sup>* mice was due to *Hoxd-13* misexpression and hence suggests that a similar mechanism is at work in the *Ul* mutation.

### Prevalence of posterior *Hoxd* genes

A striking similarity exists between the *Ul/+* phenotype and that of animals double homozygous for both *Hoxd-11* and *Hoxa-11* inactivations (Fig. 6C,D; Davis et al., 1995). However, the dominant nature of the *Ul* mutation as well as the presence of at least one dose of normally distributed *Hoxd-11* and *Hoxd-10* transcripts in *Ul/+* mice makes it unlikely that the phenotype entirely derives from a global down-regulation of group 11 gene transcription. This raises the possibility that the *Hoxd-13* gain-of-function induces a concurrent loss-of-function of group 11 genes within the *Hoxd-13* ectopic domain, without totally switching off their transcriptions, a phenomenon previously referred to as 'posterior prevalence' (Duboule, 1991). The presence of the *Hoxd-13* protein may, for example, antagonize the function of group 11 proteins through protein-protein interactions or competition for target binding sites (Duboule and Morata, 1994).

An indirect demonstration that ectopic *Hoxd-13* acts through preventing group 11 proteins achieving their functions was obtained with the *TgH[d-11/lac]<sup>Ge</sup>* allele (Figs 6B, 7B). When present in one copy, this configuration was inactive, i.e. the gain-of-function of *Hoxd-13* (arrow) was not sufficient to induce the ulna phenotype. However, two copies generated this phenotype with a full penetrance (Fig. 6B; van der Hoeven et al., 1996). Conversely, Davis et al. (1995) showed that removing two copies of group 11 genes (either from *Hoxd-11* or *Hoxa-11*, or mixed) never produced strong ulna phenotypes, this latter trait appearing only when three copies were removed. To show that both situations involved the same deficiency of group 11 functions (regardless of which proteins were present

or absent), we introduced one *TgH[d-11/lac]<sup>Ge</sup>* chromosome in mice *transheterozygous* for both the *Hoxd-11* (Favier et al., 1995) and *Hoxa-11* (Small and Potter, 1993) null alleles and recovered animals with an altered ulna (F. van der Hoeven, B. Favier, S. Potter and D. D., unpublished). Thus, while neither heterozygous *TgH[d-11/lac]<sup>Ge</sup>* nor *Hoxd-11<sup>+/-</sup>*; *Hoxa-11<sup>+/-</sup>* animals have a defective phenotype, the combination of the three alleles induced the expected alteration (though with moderate penetrance).

Therefore, the genetic and molecular analyses of the *Ul* and *TgH[d-11/lac]<sup>Ge</sup>* gain-of-function *Hoxd-13* alleles provides additional evidence supporting the existence of a functional hierarchy between *Hox* gene products. In *Ulnaless* mice, a similar situation might occur with the clear but restricted gain-of-function of *Hoxd-12* in the stylopod. An ectopic domain was detected in foetal stylopods, whereas a reduction in the length of the humerus was observed in *Ul/+* adult animals. Interestingly, this proximal domain was shown to be part of the normal transcript domains of more 3'-located genes such as *Hoxd-10*, which suggests that the overall regulatory control of *Hoxd-13* and *Hoxd-12*, in *Ulnaless* animals, had been shifted towards a more 'proximal' type of regulation. Furthermore, the alteration of the *Ul/+* humerus resembled part of the *Hoxd-9* homozygous mutant phenotype (Fromental-Ramain, 1996a) suggesting that ectopic *Hoxd-12* may, in this case, induce a group 9 loss-of-function phenotype. However, the observed slight reduction of *Hoxd-11* transcription in *Ulnaless* mice, as well as a transcriptional down-regulation of *Hoxa-11* (see the accompanying paper by Peichel et al., 1997), suggests the possibility that the phenotype results from a combined effect of both posterior prevalence and a cross-regulatory negative transcriptional control by ectopic *Hoxd-13* protein.

### Is *Ulnaless* a regulatory mutation?

While this set of data provides a tentative mechanistic explanation for the *Ulnaless*-related phenotypic alterations, it does not reveal the molecular nature of the mutation. However, *Ul* is a strong candidate for a regulatory mutation affecting several *HoxD* genes at once. In contrast to other reported naturally occurring mutations within posterior *Hox* genes, such as *SPD*, *Hd* or *HFG* (Mortlock and Innis, 1997; Mortlock et al., 1996; Muragaki et al., 1996), *Ul* probably does not interfere with one particular coding region. A plausible hypothesis involves the alteration (deletion, inversion) of one major regulatory element necessary for limb expression. *Hoxd* gene expression in limbs is a multiphasic process and is thought to involve discrete regulations, at least for the distal (digits) and proximal (forearm) segments. It is possible that a distance-dependent competition between these two elements impose different patterns to various genes depending upon their positions in the complex. While *Hoxd-13* and *Hoxd-12* are normally under strong influence of a 'distal' element, the rearrangement of this element or deletion thereof may allow a 'proximal' element to take over transcriptional controls of these genes turning them into more 'proximal' genes and forcing their expressions in zeugopods. In such a case, the molecular characterization of this mutation will help to understand complex regulatory mechanisms involving the coordinate action of several genes.

We would like to thank K. Peichel and T. Vogt for sharing results prior to publication, F. van der Hoeven for his help and colleagues

from the laboratory for comments, suggestions and sharing reagents. The laboratory is supported by funds from the Canton de Genève, the Swiss National Research Fund, the Human Frontier Program and the Claraz and Latsis foundations.

## REFERENCES

- Chan, D. C., A., Wynshaw-Boris, A. and Leder, P. (1995) Formin isoforms are differentially expressed in the mouse embryo and are required for normal expression of *fgf-4* and *shh* in the limb bud. *Development* **121**, 3151-3161.
- Davis, A. P. and Capecchi, M. R. (1994). Axial homeosis and appendicular skeleton defects in mice with a targeted disruption of *Hoxd-11*. *Development* **120**, 2187-2198.
- Davis, A. P. and Capecchi, M. R. (1996). A mutational analysis of the 5' *HoxD* genes: Dissection of genetic interactions during limb development in the mouse. *Development* **122**, 1175-1185.
- Davis, A. P., Witte, D. P., Hsieh-Li, H. M., Potter, S. S. and Capecchi, M. R. (1995). Absence of radius and ulna in mice lacking *Hoxa-11* and *Hoxd-11*. *Nature* **375**, 791-795.
- Davison, M. T. and Cattanaach, B. M. (1990). The mouse mutation *Ulnaless* on chromosome 2. *J. Hered.* **81**, 151-153.
- Dollé, P., Dierich, A., LeMeur, M., Schimmang, T., Schuhbauer, B., Chambon, P. and Duboule, D. (1993). Disruption of the *Hoxd-13* gene induces localized heterochrony leading to mice with neotenic limbs. *Cell* **75**, 431-441.
- Dollé, P. and Duboule, D. (1989). Two gene members of the murine *HOX-5* complex show regional and cell-type specific expression in developing limbs and gonads. *EMBO J.* **8**, 1507-1515.
- Dollé, P., Izpisua-Belmonte, J.-C., Tickle, C., Brown, J. and Duboule, D. (1991a). *Hox-4* genes and the morphogenesis of mammalian genitalia. *Genes Dev.* **5**, 1767-1776.
- Dollé, P., Izpisua-Belmonte, J.-C., Boncinelli, E. and Duboule, D. (1991b). The *Hox-4.8* gene is localized at the 5' extremity of the *Hox-4* complex and is expressed in the most posterior parts of the body during development. *Mech. Dev.* **36**, 3-13.
- Duboule, D. (1991). Patterning in the vertebrate limb. *Curr. Opin. Genet. Dev.* **1**, 211-6.
- Duboule, D. and Morata, G. (1994). Colinearity and functional hierarchy among genes of the homeotic complexes. *Trends Genet.* **10**, 358-364.
- Favier, B., Le Meur, M., Chambon, P. and Dollé, P. (1995). Axial skeleton homeosis and forelimb malformations in *Hoxd-11* mutant mice. *Proc. Natl. Acad. Sci. USA* **92**, 310-314.
- Featherstone, M. S., Baron, A., Gaunt, S. J., Mattei, M. G. and Duboule, D. (1988). *Hox-5.1* defines a homeobox-containing gene locus on mouse chromosome 2. *Proc. Natl. Acad. Sci. USA* **85**, 4760-4764.
- Fromental-Ramain, C., Warot, X., Lakkaraju, S., Favier, B., Haack, H., Birling, C., Dierich, A., Dollé, P. and Chambon, P. (1996a). Specific and redundant functions of the paralogous *Hoxa-9* and *Hoxd-9* genes in forelimb and axial skeleton patterning. *Development* **122**, 461-472.
- Fromental-Ramain, C., Warot, X., Messadecq, N., Lemeur, M., Dollé, P. and Chambon, P. (1996b). *Hoxa-13* and *Hoxd-13* play a crucial role in the patterning of the limb autopod. *Development* **122**, 2997-3011.
- Gérard, M., Chen, J.-Y., Gronemeyer, H., Chambon, P., Duboule, D. and Zákány, J. (1996) *In vivo* targeting of a regulatory element required for positioning the *Hoxd-11* and *Hoxd-10* expression boundaries. *Genes Dev.* **18**, 2326-2334.
- Goff, D. J. and Tabin, C. J. (1997). Analysis of *Hoxd-13* and *Hoxd-11* misexpression in chicken limb buds reveals that *Hox* genes affect both bone condensation and growth. *Development* **124**, 627-636.
- Haramis, A. G., Brown, J. M. and Zeller, R. (1995). The limb deformity mutation disrupts the SHH/FGF-4 feedback loop and regulation of 5' *HoxD* genes during limb pattern formation. *Development* **121**, 4237-4245.
- Izpisua-Belmonte, J.-C., Falkenstein, H., Dollé, P., Renucci, A. and Duboule, D. (1991). Murine genes related to the *Drosophila AbdB* homeotic genes are sequentially expressed during development of the posterior part of the body. *EMBO J.* **10**, 2279-2289.
- Kondo, T., Dollé, P., Zákány, J. and Duboule, D. (1996). Function of posterior *HoxD* genes in the morphogenesis of the anal sphincter. *Development* **122**, 2651-2659.
- Kuhlman, J. and Niswander, L. (1997). Limb deformity proteins: role in mesodermal induction of the apical ectodermal ridge. *Development* **124**, 133-139.
- Morris, T. (1967). New mutants. *Mouse News Lett.* **36**, 34.
- Mortlock, D. P. and Innis, J. W. (1997). Mutation of *HOXA13* in hand-foot-genital syndrome. *Nature Genet.* **15**, 179-180.
- Mortlock, D. P., Post, L. C. and Innis, J. W. (1996). The molecular basis of hypodactyly (*Hd*): A deletion in *Hoxa13* leads to arrest of digital arch formation. *Nature Genet.* **13**, 284-289.
- Muenke, M. and Schell, U. (1995). Fibroblast-growth-factor receptor mutations in human skeletal disorders. *Trends Genet.* **11**, 308-313.
- Muragaki, Y., Mundlos, S., Upton, J. and Olsen, B. R. (1996). Altered growth and branching patterns in synpolydactyly caused by mutations in *HOXD13*. *Science* **272**, 548-551.
- Peichel, C. L., Abbott, C. M. and Vogt, T. F. (1996). Genetic and physical mapping of the mouse *Ulnaless* locus. *Genetics* **144**, 1757-1767.
- Peichel, C. L., Prabhakaran, B. and Vogt, T. F. (1997). The mouse *Ulnaless* mutation deregulates posterior *Hoxd* gene colinearity and alters appendicular patterning. *Development* **124**, 3481-3492.
- Small, K. M. and Potter, S. S. (1993). Homeotic transformation and limb defects in *Hoxa-11* mutant mice. *Genes Dev.* **7**, 2318-2328.
- van der Hoeven, F., Zákány, J. and Duboule, D. (1996). Gene transpositions in the *HoxD* complex reveal a hierarchy of regulatory controls. *Cell* **85**, 1025-1035.
- Woychik, R. P., Maas, R. L., Zeller, R., Vogt, T. F. and Leder, P. (1990) 'Formins': Proteins deduced from the alternative transcripts of the limb deformity gene. *Nature* **346**, 850-853.
- Yamaguchi, T. P. and Rossant, J. (1995). Fibroblast growth factors in mammalian development. *Cur. Opin. Gen. and Dev.* **5**, 485-491.
- Yokouchi, Y., Nakazato, S., Yamamoto, M., Goto, Y., Kameda, T., Iba, H. and Kuroiwa, A. (1995). Misexpression of *Hoxa-13* induces cartilage homeotic transformation and changes cell adhesiveness in chick limb buds. *Genes Dev.* **9**, 2509-2522.
- Zákány, J. and Duboule, D. (1996). Synpolydactyly in mice with a targeted deficiency in the *HoxD* complex. *Nature* **384**, 69-71.
- Zákány, J., Gérard, M., Favier, B. and Duboule, D. (1997) Deletion of a *HoxD* enhancer induces transcriptional heterochrony leading to transposition of the sacrum. *EMBO J.*, in press.

(Accepted 14 July 1997)